

COSMO SYNTHESIZER

CZ-1000



OPERATION MANUAL 1

CASIO
英西

CASIO

CZ-1000

DIGITAL SYNTHESIZER

Contents

■ About the Power Supply	3
■ Name and Function of Each Part	5
■ Connections With External Equipment	12
■ How to Create Sounds with the CZ-1000	13
• PD Sound Source	13
• Envelopes	14
• Block Structure	15
■ Programmer Section	19
• Preset Tones	19
• Internal Memory Tones	19
• Cartridge Memory	20
• Compare/Recall Key	20
■ Write/Save/Load	22
■ Parameter Section	25
• Wave Form	25
• Envelope Settings	26
• DCW Key Follow	29
• DCA Key Follow	29
• Vibrato	30
• Octave	31
• Detune	31
• Line Select	32
• Ring Modulation	32
• Noise Modulation	32
• Initialize	33
■ Effect Section	34
• Bend Range	34
• Vibrato	34
• Portamento	34
• Solo key	35
• Tone Mix	35
• Key Transpose	36
■ MIDI	37
■ Care of Your Unit	41
■ Specifications	42

■ About the Power Supply

The CZ-1000 can use three kinds of power supplies — dry batteries, household electricity or a car battery.

(a) Dry Batteries

The CZ-1000 uses 6 D-size manganese dry batteries.

< Inserting the batteries >

- * Remove the lid of the battery compartment on the bottom of the unit and insert the batteries taking care not to confuse \oplus and \ominus . Always replace all 6 batteries at the same time as this will help lengthen battery life.
- * After having inserted batteries for the first time, be sure to press the "P" button. (Refer to the explanation of the P button below.)

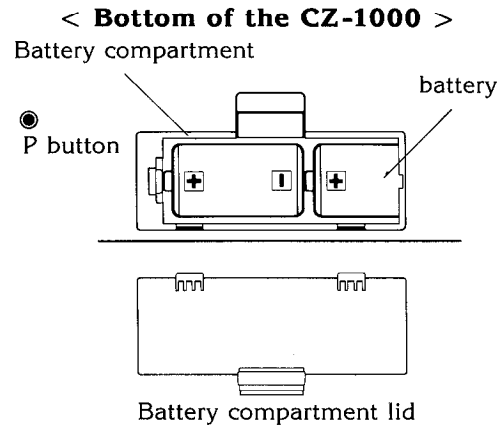

About the P button

In order to clear any bugs (software malfunctions) that can occur in the memory during battery replacement, be sure to press the P button with a pointed object ① after you have inserted batteries for the first time, and ② after you have inserted new batteries when the time that has elapsed since removal of the old batteries is more than 10 minutes. Pressing the P button causes the 16 sounds set in the internal memory before shipment to be recalled. At the same time, any new tones you have set in the internal memory will be cancelled, so please be careful.

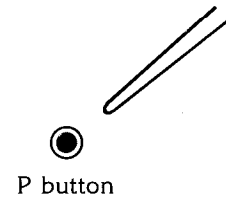

- * Be sure to press the P button when power is turned ON, otherwise it will have no effect. Battery life is about 5 hours in the case of high-performance types (SDM-1). When the batteries begin to wear out, the power indicator will start to flash. If this occurs, please replace all 6 dry batteries with new ones as soon as possible.

(b) Household electricity

- * You can use household electricity as a power supply for the CZ-1000 by connecting the special AC adaptor (AD-5, optional).

(c) Car battery

- * By connecting the special car adaptor (CA-5, optional), you can supply your CZ-1000 with power from your car's cigar lighter.

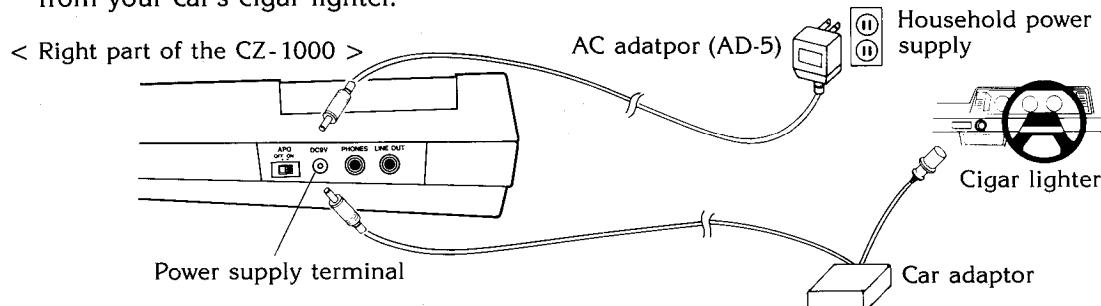

- * Even when using household electricity or a car battery, be sure that dry batteries are also inserted at the same time in order to protect the memory data.
- * When connecting or unplugging an adaptor, please be sure to turn off the power beforehand.
- * If you do not intend to use your instrument for longer periods, please remove the dry batteries in order to avoid damage due to battery leakage.
- * Please be sure to use only the specified AC or car adaptors. Any damage caused by the use of other adaptors is not covered by the warrantee.
- * If an adaptor is used for any length of time, the adaptor itself will heat up somewhat, but this is no cause for alarm. However, do unplug the adaptor from the wall receptacle or the cigar lighter when not using it.

★ Concerning protection of the memory contents

The tone data entered into the internal memory or another will be backed up by the inserted batteries and not be cancelled even if the power switch is turned off when an AC adaptor or car adaptor is connected as well as during use of a DC power supply (dry batteries). If, however, no batteries are inserted or the inserted batteries are already spent, the memory contents may be erased or altered, so please be careful.

- * The memory contents will not be erased during battery replacement if the new batteries are inserted within 10 minutes after the old ones have been removed. Therefore please insert 6 new batteries within this space of time.
- * Battery life is about 12 months in case of using the battery only for protecting memories.

★ Auto-Power-Off function



- **When the APO (Auto-Power-Off) switch is set to ON**
This function automatically turns power off approximately 6 minutes after the last operation was performed in order to avoid unnecessary power consumption. If this has happened, set the power switch to OFF and then turn the power on again by setting it back to ON.
- **When the APO (Auto-Power-Off) switch is set to OFF**
Setting the APO switch to OFF cancels the Auto Power Off function explained above.

When you use this instrument while the power indicator has started to flash due to weakening of the batteries, the power will turn off automatically just before the data in the internal memory is erased in order to protect this data, regardless of whether the APO switch is set to ON or OFF. When this happens, stop using the instrument and immediately replace the used batteries with new ones.

- * The types of data protected by battery back-up even when power is turned off are as follows.
 - Internal memory tone data
 - Tone data in the compare/recall area
 - Master tune
 - Key transpose
 - Bend range
 - Portamento time
 - Tone numbers and levels of the Tone Mix function

■ Name and Function of Each Part

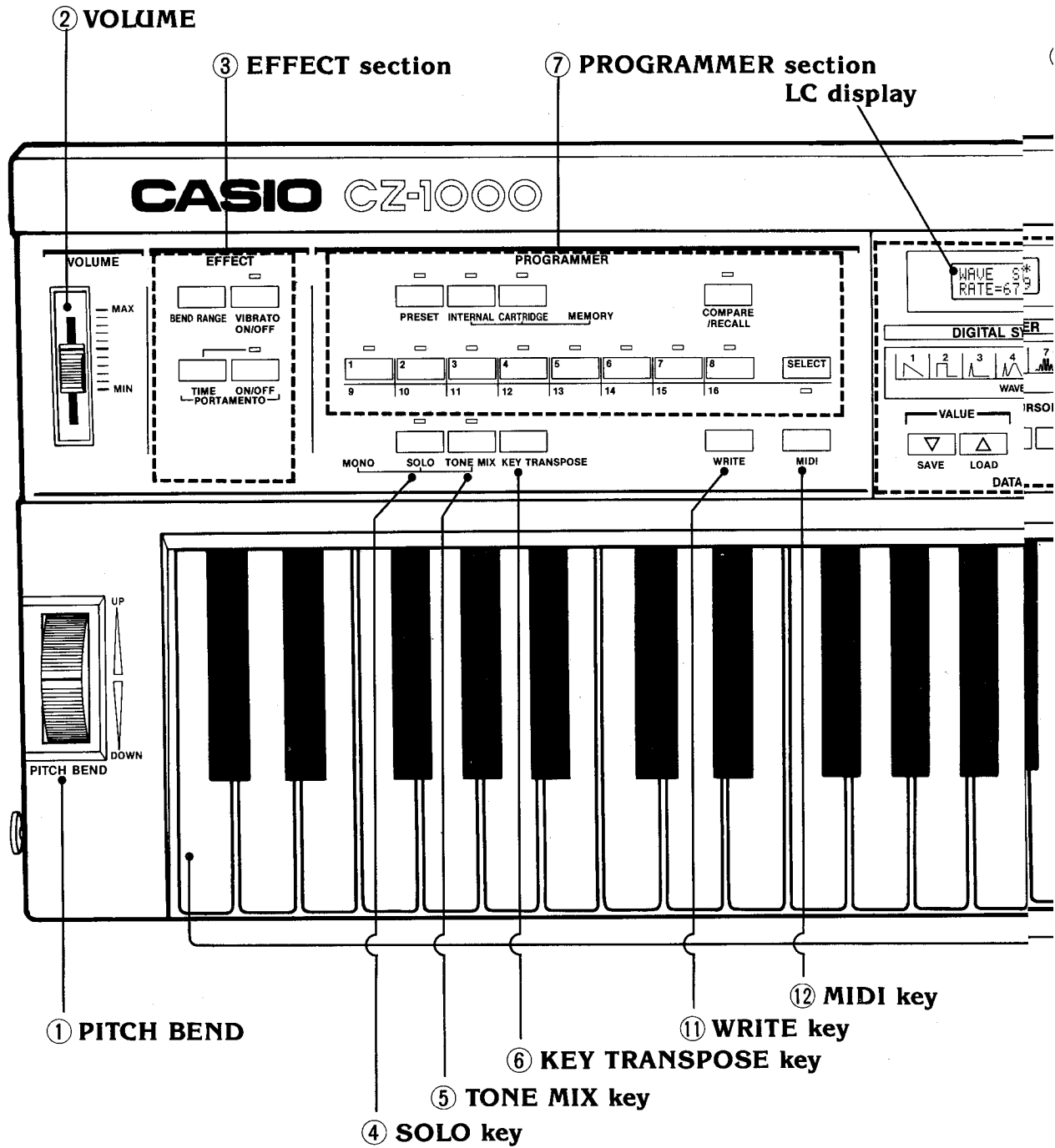

⑧ DATA ENTRY section

⑨ PARAMETER section

⑩ MASTER TUNE

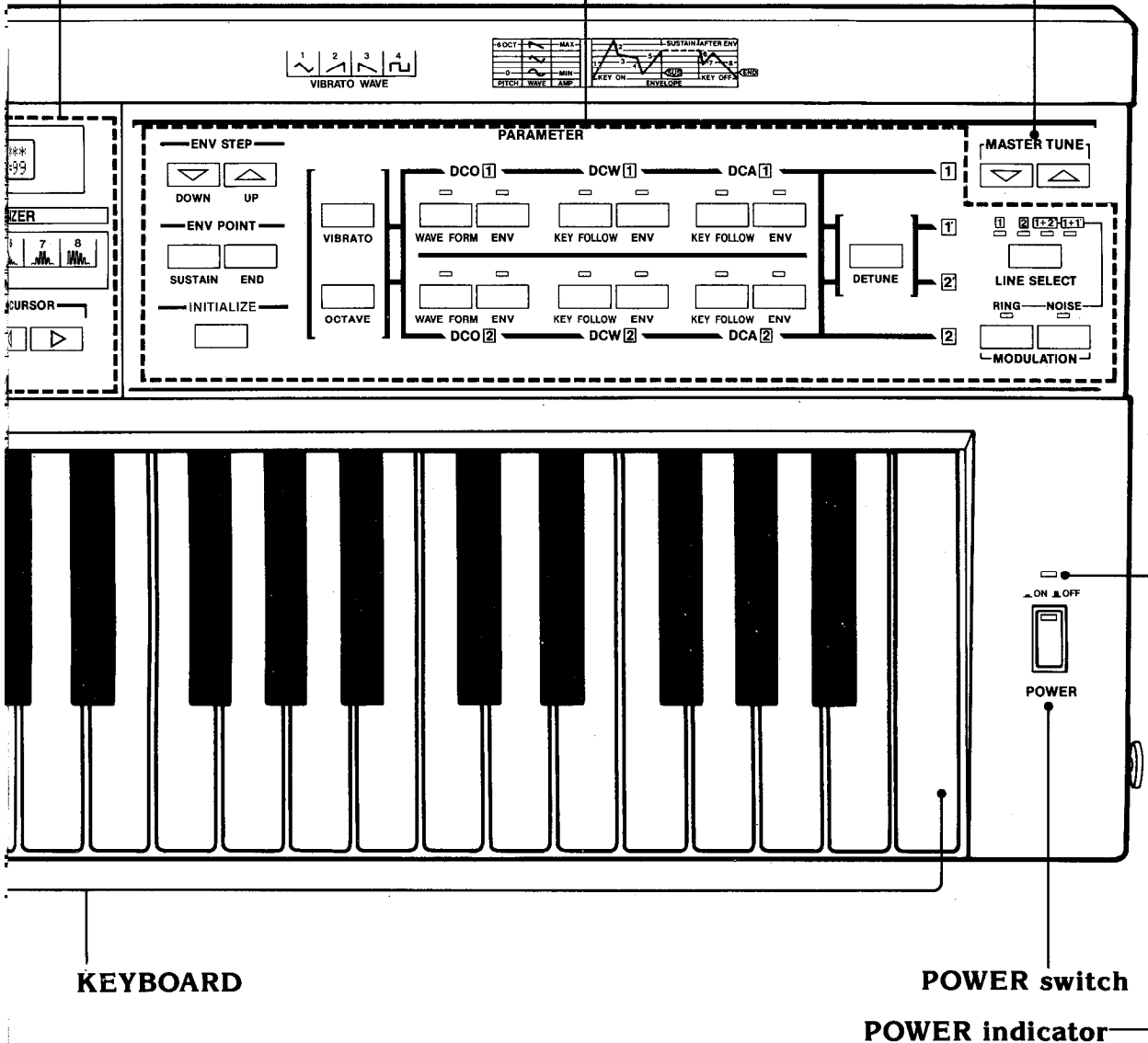

KEYBOARD

POWER switch
POWER indicator

① PITCH BEND

By rotating this wheel, you can control the pitch within the variable range set with the Bend Range parameter in the Effects section.

② VOLUME control

This control allows you to adjust the output level appearing at the line out terminal as well as the headphone volume.

③ EFFECT section

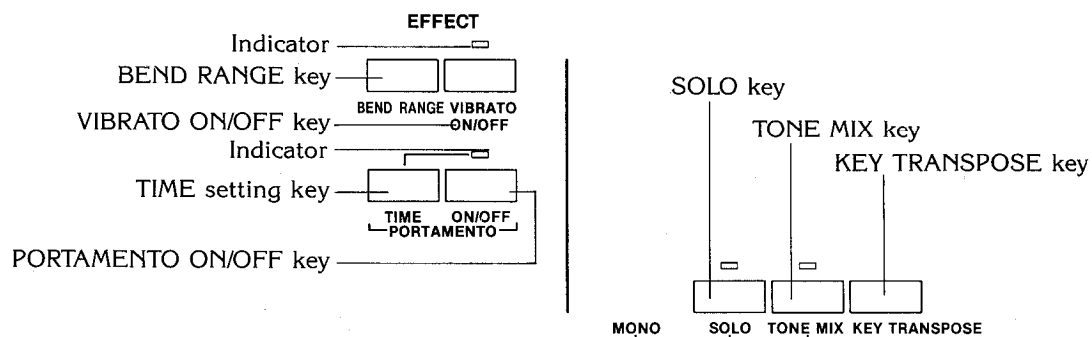

BEND RANGE key

Press this button to set the variable range of the pitch bend. Data entry itself is performed in the Data Entry section.

VIBRATO ON/OFF key

This key is used to switch the vibrato effect on and off. When this effect is on, the indicator is lit.
* When the vibrato depth is "00", the indicator turns off automatically and this key does not operate.

PORTAMENTO ON/OFF key

This key switches the portamento effect on and off. When this effect is on, the indicator is lit.

TIME setting key

This key is pressed when you want to set the portamento time. Data entry itself is performed in the Data Entry section.

④ SOLO key

Press this key when you want monophonic sound. The indicator is lit when the Solo effect is on.

⑤ TONE MIX key

Press this key when you want to mix two tones which will then sound simultaneously. The indicator is lit when this function is on. (The keyboard will be switched to monophonic.)

⑥ KEY TRANSPOSE key

Press this key when you want to use the Transpose function. Setting of the keyboard pitch is performed using and the Data Entry section.

⑦ PROGRAMMER section

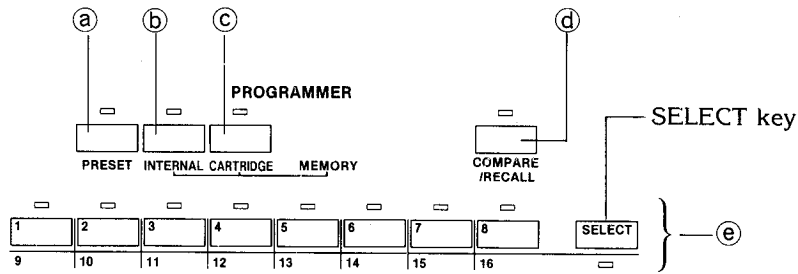

Ⓐ PRESET key

Press this key when you want to recall one of the preset tones from the memory. When the preset tone mode is selected, the indicator lights up.

Ⓑ INTERNAL MEMORY key

This key is used when you want to recall a tone from the internal memory or when you would like to store a new tone in the internal memory. When the internal memory mode is selected, the indicator lights up.

Ⓒ CARTRIDGE MEMORY key

When you want to memorize a tone in the optional RAM cartridge or recall a tone from the cartridge memory, press this key. When the cartridge memory mode is selected, the indicator lights up.

Ⓓ COMPARE/RECALL key

When you have altered a tone recalled from a memory using the Parameter section and Data Entry section, you can compare it with the previous tone (the one before the alterations were made) by pressing this key. Pressing it once selects the previous tone, pressing it once again selects the altered tone.

When a tone has been altered, the indicator of this key automatically lights up, showing that the selected sound is being changed.

Ⓔ TONE selectors

These keys are used to recall the 16 individual tones from each of the memories Ⓐ, Ⓑ and Ⓒ. When a tone is selected, the respective indicator lights up. When the SELECT key is on (its indicator is lit), pressing the tone selectors will select tones with numbers from 9 to 16.

⑧ DATA ENTRY section

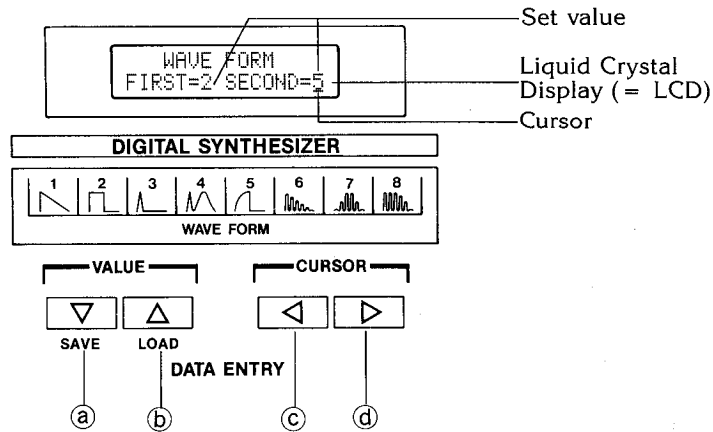

① key

Press this key when you want to save an internal memory tone in a RAM cartridge. Also use this key to set the tone data shown on the LCD (= Liquid Crystal Display). Each time this key is pressed, the value will decrease by 1. Keeping the key depressed causes a continuous decrease of the value.

② key





Press this key when you want to load a RAM cartridge tone into the internal memory. Also use this key to set the tone data shown on the LCD (= Liquid Crystal Display). Each time this key is pressed, the value will increase by 1. Keeping the key depressed causes a continuous increase of the value.

③ key/④ key

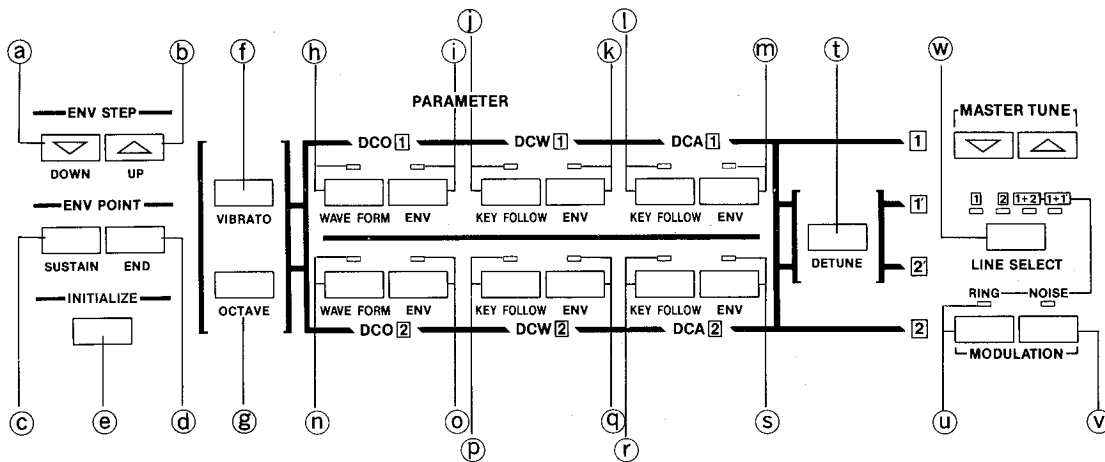
Use these keys to move the cursor on the LCD (= Liquid Crystal Display) which indicates the tone data being set. Pressing the key moves the cursor the left, pressing the key moves it to the right.

⑨ PARAMETER section



- a)  **key** / b)  **key**
 Use these keys to select the step number for each envelope (DCO1, DCW1, DCA1, DCO2, DCW2 and DCA2 envelope). Each time the  key is pressed, the step number will decrease by one. Each time the  key is pressed, the step number will increase by one.
- c) **SUSTAIN key**
 Press this key to set the sustain point for each envelope. Pressing the key again releases the sustain point setting mode.
- d) **END key**
 Press this key to set the end point for each envelope. Pressing the key again releases the end point setting mode.
- e) **INITIALIZE key**
 Pressing this key initializes the settings of the various parameters (sets the respective data to 0), thus making it easier to start creating sounds right from the beginning. To use this function, press the INITIALIZE key and then simultaneously press the key of the parameter you want to change.
- f) **VIBRATO key**
 Press this key when you want to set the vibrato effect independently for each tone. Data setting itself is performed in the Data Entry section.
- g) **OCTAVE key**
 Pressing this key lets you shift the pitch range of each tone up or down in one octave steps. Data setting itself is performed in the Data Entry section.
- h) **WAVE FORM key**
 Press this key when you want to select the basic wave form for Line 1. When this key is set to on, its indicator lights up.
- i) **DCO envelope key**
 This key lets you set the pitch envelope for Line 1. When this key is selected, its indicator lights up.
- j) **DCW KEY FOLLOW key**
 Press this key when you want to make the wave form of the Line 1 DCW approach a pure sine wave according to the pitch of the keys being played.
- k) **DCW envelope key**
 Press this key when you want to set the wave envelope for Line 1. When this key is selected, its indicator lights up.
- l) **DCA KEY FOLLOW key**
 Use this key when you want to effect temporal changes in the envelope level of the Line 1 DCA.
- m) **DCA envelope key**
 Press this key when you want to set the parameters of the Line 1 amplifier envelope. When this key is selected, its indicator lights up.
- n) **WAVE FORM key**
 Press this key when you want to select the basic wave form for Line 2. When this key is set to on, its indicator lights up.
- o) **DCO envelope key**
 This key lets you set the pitch envelope for Line 2. When this key is selected, its indicator lights up.

Ⓟ **DCW KEY FOLLOW key**

Press this key when you want to make the wave form of the Line 2 DCW approach a pure sine wave according to the pitch of the keys being played.

Ⓠ **DCW envelope key**

Press this key when you want to set the wave envelope for Line 2. When this key is selected, its indicator lights up.

Ⓡ **DCA KEY FOLLOW key**

Use this key when you want to effect temporal changes in the envelope level of the Line 2 DCA.

Ⓢ **DCA envelope key**

Press this key when you want to set the parameters of the Line 2 amplifier envelope. When this key is selected, its indicator lights up.

Ⓣ **DETUNE key**

Pressing this key detunes the pitch of Line 1 or Line 2 without changing the tone, so you get Line 1' or Line 2'.

Ⓤ **RING MODULATION key**

Pressing this key causes Line 1' or Line 2' to be ring modulated by Line 1. When this key is selected, its indicator lights up.

Ⓥ **NOISE key**

Pressing this key causes Line 1' or Line 2' to be modulated by noise. When this key is selected, its indicator lights up.

Ⓦ **LINE SELECT key**

This key allows you to select a line depending on the type of sound you want to create and to combine the lines as you wish. Pressing the key changes line selection in the order 1 → 2 → 1+1 → 1+2 and so on. The indicator above the selected line combination lights up.

⑩ **MASTER TUNE keys**

These keys are used to change the pitch of the entire keyboard.

⑪ **WRITE key**

Use this key when you want to store a newly created sound in the internal memory or in an optional RAM cartridge, when you want to save an internal memory tone in the RAM cartridge, or when you want to load a tone from the RAM cartridge into the internal memory.

⑫ **MIDI key**

Pressing this key sets the CZ-1000 to MIDI data communication mode allowing data transfer to and reception from other units connected via MIDI cable.

■ Connections With External Equipment

● Back of instrument

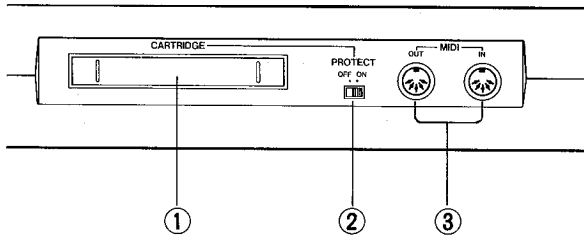

① Cartridge insertion slot

Insert a RAM cartridge (optional) here. A RAM cartridge is capable of storing the data for 16 tones.

② PROTECT switch

In order to avoid accidental erasure of internal memory or cartridge memory contents (tones), the CZ-1000 is equipped with a memory protect function. When the PROTECT switch is set to ON, the memory is protected, meaning that you cannot memorize new tone data or save and load data between the internal memory and the cartridge memory. These operations can only be performed when the PROTECT switch is set to OFF. (See page 22 for details.)

③ MIDI Input/Output terminals

Use the terminal for connection of the CZ-1000 to other keyboards, personal computers, etc. provided with MIDI terminals.

④ APO (Auto Power Off) switch

When the APO switch is set to ON, the Auto Power Off function operates to avoid unnecessary power consumption. To cancel this function, set the APO switch to OFF. (See page 4 for details.)

⑤ Power terminal

Connect an AC adaptor (optional) or a car adaptor (optional) here.

⑥ Headphone jack

When using headphones to monitor the sound of the CZ-1000, connect them to this jack.

⑦ Output jack

Connect this jack to your stereo, to a keyboard amplifier or mixer, etc.

⑧ P button

Press this button when you want to recall the original internal memory tones or clear any bugs. (See page 3 for details)

● Right side of instrument

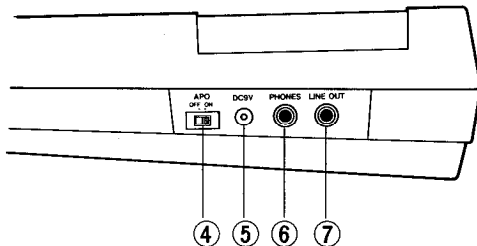

● Bottom of instrument

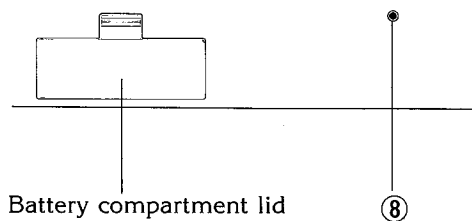

■ How to Create Sounds with the CZ-1000

• PD (Phase Distortion) sound source

The CZ-1000 uses the unique PD (Phase Distortion) sound source system developed by CASIO. As the words "phase distortion" indicate, this system distorts the phase angle of a sine wave or cosine wave written into a ROM when read, thus creating a variety of wave forms. The pattern of the distorted reading phase angle determines the DCO (corresponds to the VCO in an analog synthesizer) wave form. The amount of distortion of the reading phase angle (depth of modulation) is determined by the momentary value of the DCW envelope (which corresponds to the VCF of an analog synthesizer).

(Fig. 1)

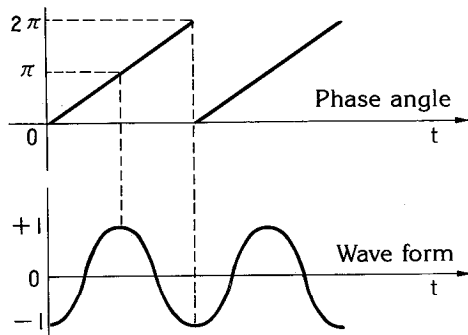

(To make the explanation easier to understand, the polarity of the cosine wave $\cos \theta$ has been inverted.)

Fig. 1 shows what happens when the phase angle of the cosine wave written into the ROM is read in linear form—the cosine wave is output as it is.

The phase angle is read at a fixed speed, taking on values from 0 to 2π .

Next, let us see what happens when the reading speed from 0 to π is speeded up while the reading speed from π to 2π is slowed down.

(Fig. 2)

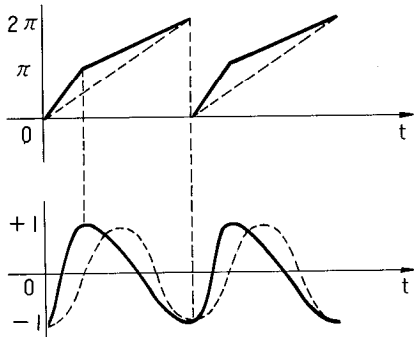

As shown in Fig. 2, the reading of the phase angle is now no longer linear but distorted, while the output cosine wave has become similar to a saw-tooth wave.

What happened if we then make the reading speed from 0 to π faster than before and further slow down the reading speed from π to 2π ?

As you can see in Fig. 3, the output cosine wave is now an almost perfect saw-tooth wave.

(Fig. 3)

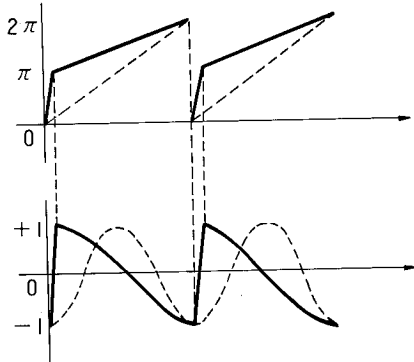

This PD sound source system can thus easily output all kinds of wave forms other than a cosine wave by simply distorting the reading phase angle of a cosine wave (or sine wave) stored in a ROM. This unique Phase Distortion system, which can modulate cosine waves, thus proves to be a truly revolutionary sound source.

Figures 1 to 3 showed the kind of reading phase angle distortion pattern that occurs when the phase angle reading speed from 0 to π is accelerated while the phase angle reading speed from π to 2π is slowed down. A pattern such as this is created when the saw-tooth wave form is selected with the DCO Wave Form parameter.

If a different kind of wave form is selected with the DCO Wave Form parameter, the reading phase angle is distorted to that respective pattern. The CZ-1000 can thus output a whole variety of wave forms.

The intensity of the reading phase angle distortion is controlled by the DCW envelope's momentary value, meaning that it can be changed over time. If the DCW envelope is set as shown in Fig. 4, an undistorted cosine wave is output at point (a), while distortion is at its maximum at point (b) so that a saw-tooth wave is output as shown in Fig. 3. At point (c), distortion has become less (meaning the intensity of the modulation has decreased), so that a wave form is output that lies somewhere between the kind of cosine wave shown in Fig. 2 and a perfect saw-tooth wave.

(Fig. 4)

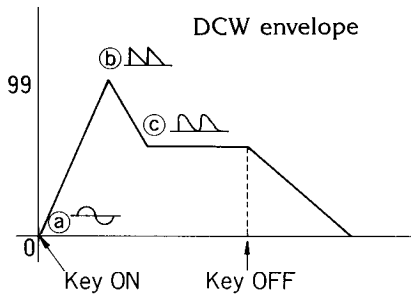

Points to remember:

- 1) The pattern of the reading phase angle distortion corresponds to the wave form selected with the DCO WAVE FORM parameter.
- 2) The amount of reading phase angle distortion (intensity or depth of modulation) is determined by the momentary value of the DCW envelope.

• **Envelopes**

The CZ-1000 has independent envelope generators for each of the two DCO/DCW/DCA systems. The envelopes generated by these envelope generators control the changes in pitch, tone color and sound volume over time. The envelope generators of the CZ-1000 let you set complex envelopes with up to 8 steps. In addition, the Sustain Point (which determines the level at which a sound is held as long as a key is being pressed) can be set at will. This means that you have much more freedom than with conventional envelope generators limited to ADSR (see below), giving you infinite possibilities for sound creation.

(Fig. 1)

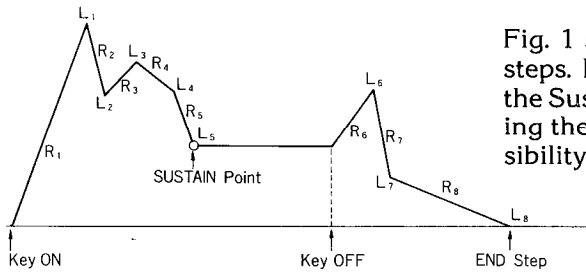
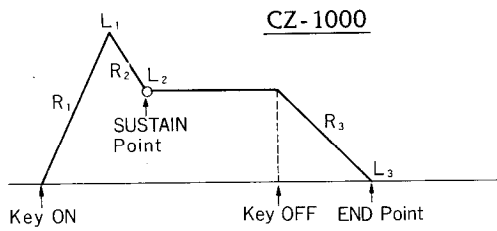

Fig. 1 shows an example of an envelope using all 8 steps. In this example, there are two attacks before the Sustain Point as well as a third attack after releasing the keys. This shows how you even have the possibility of setting an "after-envelope".

R_n and L_n (n = 1 to 8) indicate the rate (speed of level change, "slope") and level (final level reached in a step) respectively. Within a particular envelope, the level L_n is reached after the slope R_n to complete step n. Following the arrival at L_n, step n + 1 begins (with slope R_{n+1}). The only exception is the step in which the Sustain Point has been set, which is step 5 in our example in Fig. 1. During this step, the sustain level (the level set for the step containing the sustain point) will be held as long as a key is being pressed, without moving on to the next step. As soon as the key is released, the following envelope step will commence with the corresponding slope (rate). Fig. 1 shows an example of an envelope making use of all 8 steps. Of course, it is up to you how many steps you want to use.

(Fig. 2)



(Fig. 3)

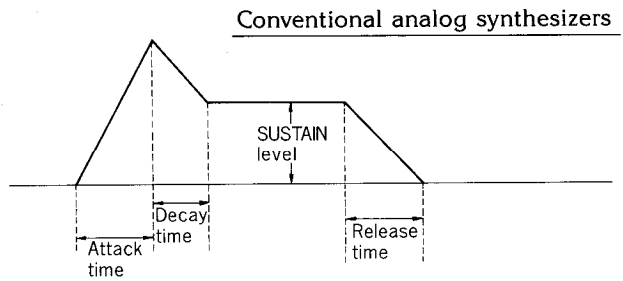

With conventional analog synthesizers, an envelope is usually set according to 4 parameters — attack time, decay time, sustain level and release time. This is what is called an “ADSR” type envelope (ADSR being the initial letters of the 4 parameters) as shown in Fig. 3. In order to set an ADSR envelope with the CZ-1000’s envelope generator, you only have to use 3 steps. (Fig. 2)

• Block Structure

(Fig. 1)

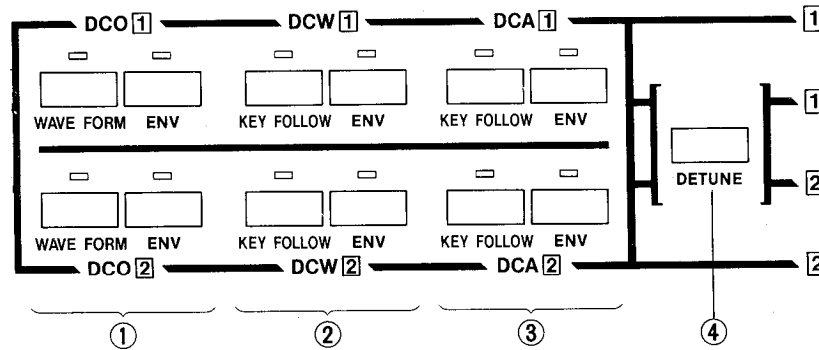

The CZ-1000 has two sound generation lines, each consisting of DCO, DCW and DCA. The sound from each of these two lines can be output either directly or in a detuned form (with a different pitch). This means that in effect the structure of the CZ-1000 sound generation system offers 4 lines. (Fig. 1)

The line directly output from DCO 1 is called Line 1 (1), the detuned output Line 1' (1'). In the same manner, the line directly output from DCO 2 is called Line 2 (2), the detuned output Line 2' (2').

The following is a brief explanation of the various parts of Fig. 1.

① Digital Controlled Oscillators (DCO 1, DCO 2)

The Digital Controlled Oscillators correspond to the VCOs (Voltage Controlled Oscillators) used in analog synthesizers. As parameters, the DCOs have Wave Form and Envelope Generator parameters. These parameters select the basic wave form (Wave Form) and control the changes in pitch over time after a key has been pressed.

As shown in Fig. a, you can choose from 8 kinds of basic wave forms (from SAW-TOOTH to RESONANCE) as well as being able to combine any two* of these wave forms to create wave forms such as those shown in Fig. b. This means that altogether, you have a selection of 33 wave forms to choose from according to the sound you want to create.

(Fig. a)

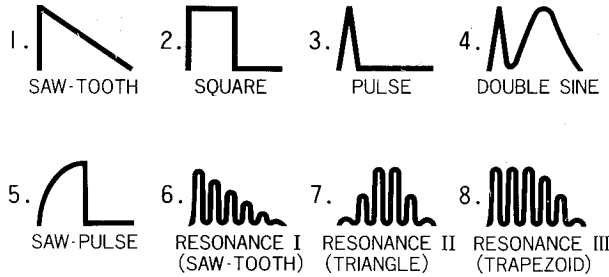

(Fig. b)

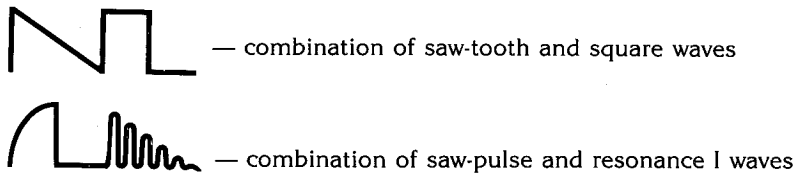

* Except the resonance wave forms from 6 to 8, which cannot be combined.

- The change of pitch over time is controlled by the envelope generator. This means that the pitch changes according to the rate (slope) and level (final level in a step) that have been set for each step.

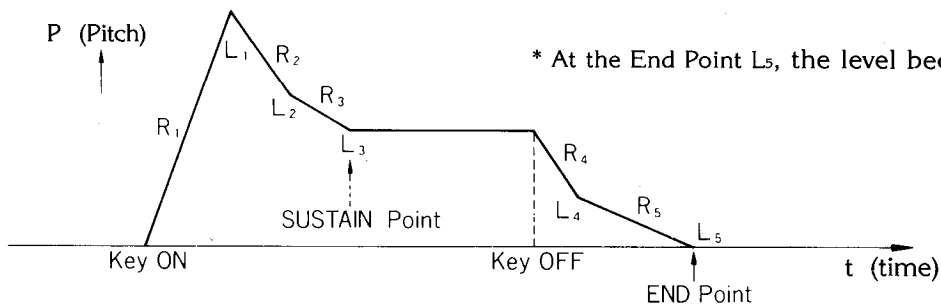

② Digital Controlled Wave (DCW 1, DCW 2)

The Digital Controlled Wave section corresponds to an analog synthesizer's VCF (Voltage Controlled Filter). The parameters of this section are Key Follow and Envelope Generator parameters. Key Follow controls the wave form according to the pitch of the keys being played, while Envelope parameters control the change over time of the wave form after a key has been pressed.

- The Key Follow parameter has the function of making the wave form gradually approach a pure sine wave (or cosine wave) the higher the pitch of the key being pressed. It can be set to one of 9 different levels. (Fig. 1)

(Fig. 1)

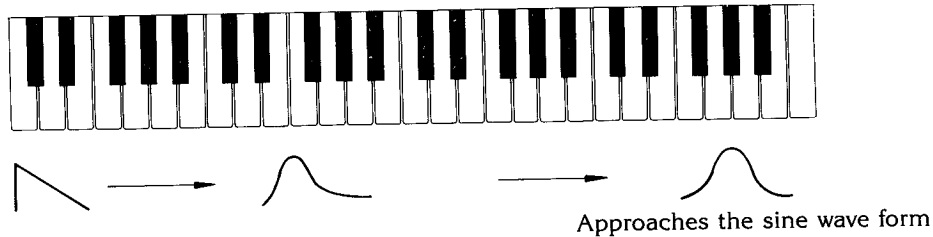

- The change of the wave form over time is controlled by the envelope generator. The wave form depends on the momentary value of the envelope. With the PD system, the change is performed starting with a pure sine wave and ending with the basic wave form set in the DCO section.

(Fig. 2)

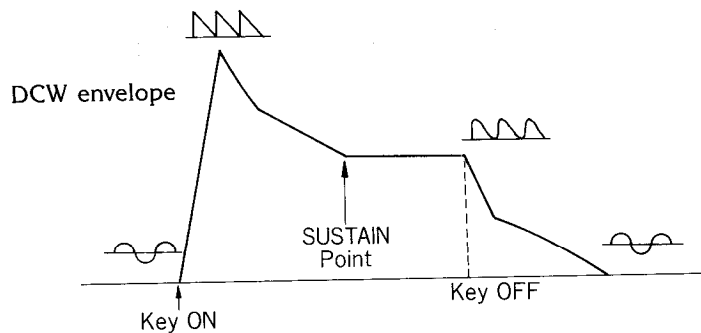

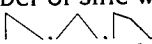
If one of the basic resonance wave forms I to III has been selected in the DCO section, the number of sine waves (that is to say, the sine wave frequency) within one of the window wave forms  is altered between 1 and 16 according to the momentary value of the envelope, achieving the same effect as if the resonance level of the VCF in an analog synthesizer had been raised. This is very effective when you want to accentuate a particular frequency range. (See Fig. 3.)

(Fig. 3)

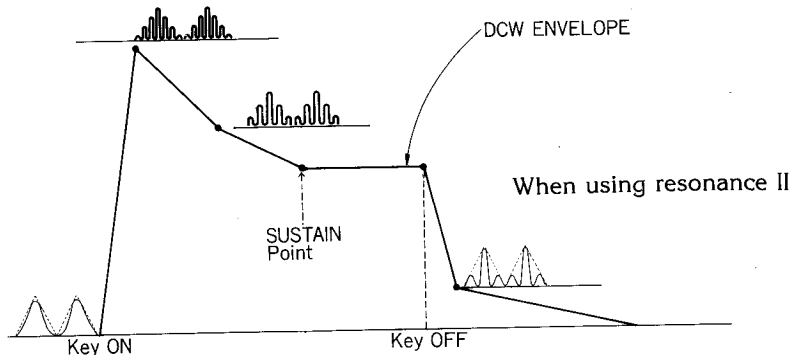

③ Digital Controlled Amplifiers (DCA 1, DCA 2)

The Digital Controlled Amplifiers correspond to the VCA (Voltage Controlled Amplifier) in an analog synthesizer. As parameters, the DCAs use Key Follow and Envelope Generator parameters. Key Follow controls the duration of the envelope's effect according to the pitch of the keys being played, while the Envelope parameters control the change in volume over time when a key is being pressed.

The Key Follow parameter has the function of shortening the duration of the envelope the higher the pitch of the key being played. This is very practical when you want to create the sounds of instruments such as piano or guitar (where strings are hit or plucked) since the duration of their sounds decreases the higher the pitch. (See Fig. 1.)

(Fig. 1)

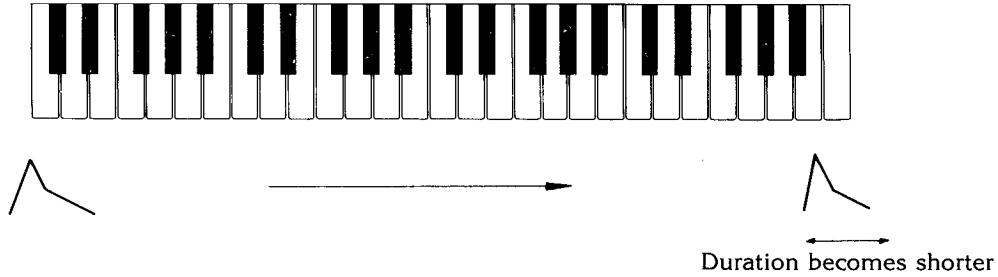

- The change of volume (amplitude) over time is controlled by the envelope generator. This means that the volume changes according to the rate (slope) and level (final level in a step) that have been set.

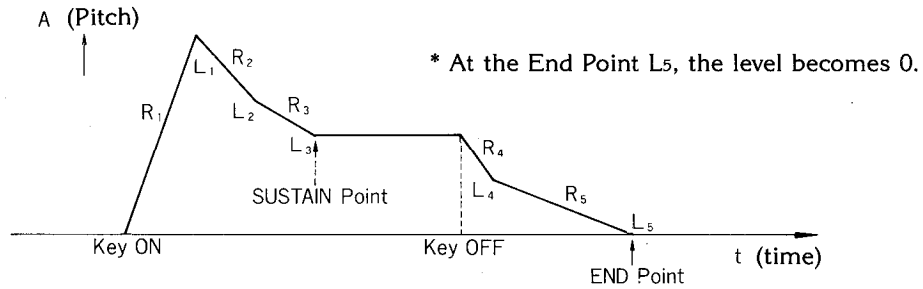

④ Detune

This function detunes (alters) the pitch of Line 1 or Line 2, outputting their sounds as Line 1 and Line 2 respectively. The detuning amount can be set freely in the range between 1.7 cents (1/60 of a half-tone) and about 4 octaves both upward and downward.

- * If the NOTE value of the detune function is set to 0, Line 1 = Line 1 and Line 2 = Line 2.

■ Programmer Section

The CZ-1000 is equipped both with a preset memory containing 16 tones created by professional musicians as well as with an internal memory that allows you to store the data for 16 other tones that you have altered to suit your individual taste or created all by yourself. In addition, you can insert an optional RAM cartridge and increase the memory capacity by a further 16 tones. This means that you then have a total of 48 different sounds at your disposal any time which can be recalled instantly.

• Preset Tones

After connecting your new synthesizer to a keyboard amplifier or other external amplifier and speakers, set the POWER switch to on. The preset memory tone 1 will be selected automatically and the PRESET indicator as well as the indicator of tone no. 1 will light up. The display shown below will appear on the LCD. If you now press any tone selector key from no. 1 to no. 8, the respective tone will be selected. Pressing the SELECT key lets you choose tones with numbers 9 to 16. Try playing your new instrument with each of these 16 preset tones.

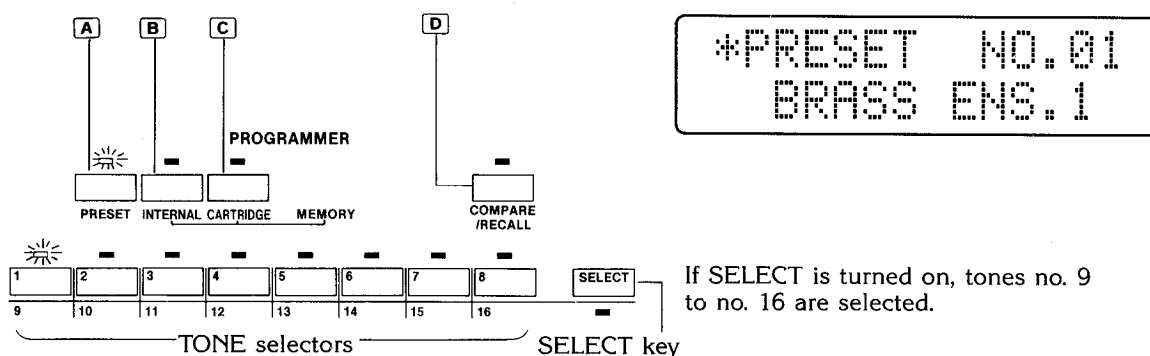

• Internal Memory Tones

When you have altered a preset tone or created a completely new tone by yourself, the internal memory offers you the possibility to store up to 16 of such tones.

To recall the internal memory tones, press the INTERNAL Memory key and then choose the tone you want by pressing the corresponding tone selector.

Your CZ-1000 was shipped with 16 sample sounds programmed into the internal memory. When you store new sounds of your own, these pre-programmed sounds will of course be erased. However, you can recall them again by pressing the P button. (See page 3)

Preset tones

1	BRASS ENS.1	9	BRASS ENS.2
2	TRUMPET	10	VIBRAPHONE
3	VIOLIN*	11	CRISPY XYLOPHONE
4	STRING ENS.1	12	SYNTH. STRINGS
5	ELEC. PIANO	13	FAIRY TALE
6	ELEC. ORGAN	14	ACCORDION
7	FLUTE*	15	WHISTLE*
8	SYNTH. BASS	16	PERCUSSION

Internal memory tones

	NAME OF TONE	*SOUND DATA No.		NAME OF TONE	*SOUND DATA No.
1	FANTASTIC PIANO	9	9	FUNKY CLAVI.	13
2	BRASS ENS.3	3	10	SOFT ORGAN	7
3	SYNTH. GLOCKEN	14	11	CARILLON	29
4	STRING ENS.2	4	12	SOUTHERN WING	39
5	BLUES HARMONICA	19	13	SYNTH. STRING 2	6
6	XYLOPHONE	15	14	SYNTH. BLOCKS	30
7	FANTASTIC SOUND 1*	41	15	FANTASTIC SOUND 2*	42
8	FAT BASS	26	16	STEEL DRUM 1	33

* Those tones listed in the table that are marked with an "*" are 8-voice polyphonic. All others are 4-voice polyphonic.

* The "sound data number" of the internal memory sounds indicates the number of the sound as listed in the enclosed "Sound Data Book".

• Cartridge Memory

If you insert an optional RAM cartridge, you can increase the memory capacity by a further 16 tones. You can then store the data for 32 new sounds in all, including those in the internal memory.

< Inserting and removing the RAM cartridge >

Please insert by pushing firmly.

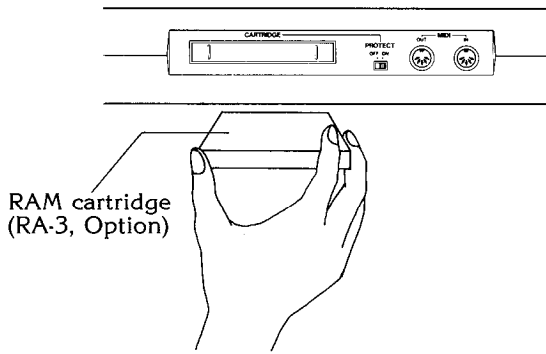

* Insertion and removal of the cartridge should be performed only when the power has been turned off.

If the RAM cartridge is inserted or removed with the power turned on, the data in the cartridge may change, the keyboard may lock up and produce no sound, or you may no longer be able to turn off power at all. To avoid such problems, follow the instruction above.

The cartridge memory tones can be recalled by first pushing the CARTRIDGE Memory key and then selecting the tone with the corresponding tone selector.

* When no RAM cartridge is inserted, it is not possible to select any cartridge memory tones even if you press the CARTRIDGE Memory key.

• COMPARE/RECALL Key

As soon as you change any parameter of preset, internal memory or cartridge memory tone data by operating the Data Entry section, the altered tone data will be stored temporarily in a special compare/recall area.

If there has been any alteration in a tone you have recalled, this altered tone data is immediately and automatically stored in the compare/recall area and the indicator of the COMPARE/RECALL key will light up. If you now press the COMPARE/RECALL key, the sound as it was preceding the alteration will be recalled. Pressing the COMPARE/RECALL key again will restore the altered sound, and so on. This practical feature thus allows you to continuously compare the sound before and after an alteration.

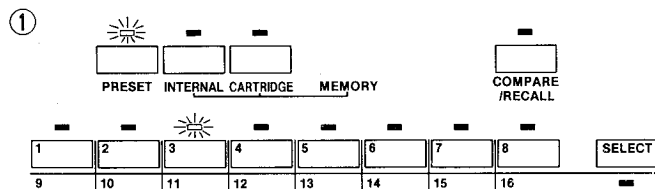

← This shows the condition when preset tone no. 3 has been selected.

② Using the Parameter section and the Data Entry section, alter the tone data.

③

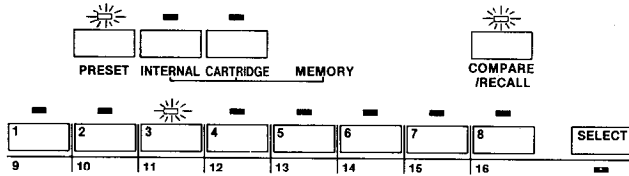

← The indicator of the COMPARE/RECALL key will light up, indicating that the tone data of preset tone no. 3 has been altered.

④



Press the COMPARE/RECALL key.



⑤

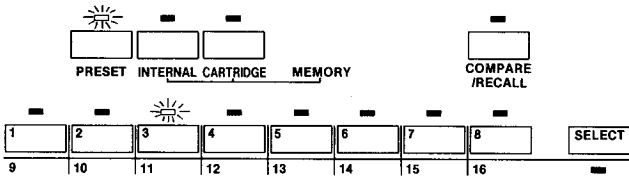

← Here, the tone of preset no. 3 is recalled as it was before the alteration of the data.

- If you recall a second tone and start altering its data after a previous tone has been recalled and the data altered, the compare/recall area will then contain only the altered data of the second tone while the altered data of the previous tone will be erased.
- Once you have created an important tone, be sure to store it in the internal memory or cartridge memory.
- Once you have started altering tone data, the LED of the COMPARE/RECALL key will remain lit even if you return to the same data as the original tone.

■ WRITE / SAVE / LOAD

With the CZ-1000, you can write (memorize) the tone data of altered tones or newly created tones to the internal memory or cartridge memory, save all tone data stored in the internal memory in the cartridge memory at once and also load all tone data in the cartridge memory to the internal memory in a single operation.

• Memory Protect function

In order to prevent inadvertent erasure of tone data stored in the internal memory or cartridge memory, the CZ-1000 is equipped with a Memory Protect function. As long as the Protect switch on the back of the unit is set to ON, both the internal memory and the cartridge memory are protected and cannot be erased.

- * It is therefore necessary to set this switch to OFF when you want to perform any of the functions Write, Save or Load.
- * As soon as Write, Save or Load operation has been completed, please be sure to set the Protect switch to ON again in order to protect your valuable tone data.

(a) Write

The tone data of altered tones or newly created tones can be written to (memorized in) the internal memory or cartridge memory with this function, where it is then safely stored.

— Writing procedure —

- ① Set the Protect switch on the back of the unit to OFF. (If it is left in the ON position, the following display will appear and you will not be able to save your data with Write.)

< LCD >

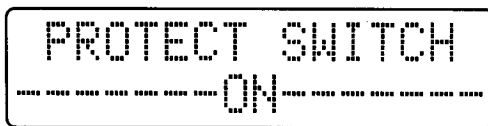

- ② Press the WRITE key and keep it depressed until step ④ of this procedure has been completed. All indicators in the Programmer section will go out when you press this key.

< LCD >

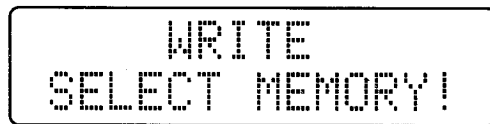

- ③ While keeping the WRITE key depressed, also press either the INTERNAL Memory key or the CARTRIDGE Memory key. (The respective indicator will light up.)

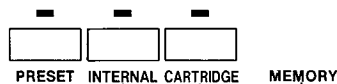

(Select the memory to which you want to write.)

- ④ Press the tone selector key corresponding to the memory number you want to write the tone to (If you want to memorize your new tone as no.9~no.16, first press the SELECT key.)

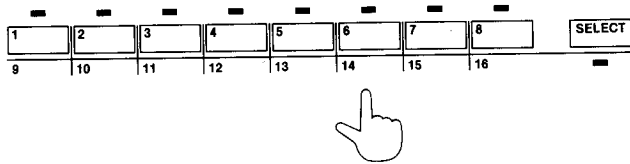

< LCD >

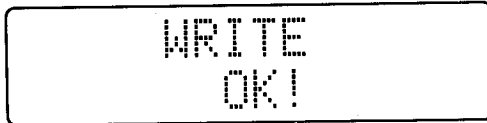

→ As soon as this message is displayed, you can lift your finger from the WRITE key as well as the tone selector.

The Write procedure is thus completed. Writing tone data to a memory will erase the tone data previously stored in the memory with the respective tone number. We therefore suggest that you make sure the tone data in the memory you wish to write to is no longer needed before you actually perform writing. To do so, simply use the Compare/Recall key to recall the tone you are about to erase.

* After completion of the Write procedure, be sure to set the Protect switch back to on.

If you perform a Write operation after having recalled a tone with the Programmer section without altering any tone data, the tone data is written to (stored in) the respective memory as it is.

(b) Save

This function lets you save all tone data stored in the internal memory in the cartridge memory in a single operation. You can then proceed to store newly created sounds in the internal memory, thus increasing your library of tones.

— Save procedure —

- ① Set the Protect switch on the back of the unit to OFF.
- ② While pressing the WRITE key, also press the SAVE key ().

< LCD >

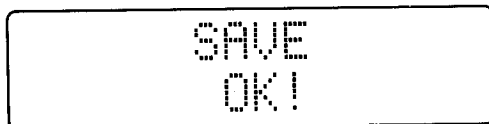

→ As soon as this message is displayed, you can lift your finger from the WRITE key as well as the SAVE key.

- ③ Set the Protect switch to ON again.

(c) Load

With this function, you can load all tone data in the cartridge memory to the internal memory in a single operation.

— Load procedure —

- ① Set the Protect switch on the back of the unit to OFF.
- ② While pressing the WRITE key, also press the LOAD key ().

< LCD >



→ As soon as this message is displayed, you can lift your finger from the WRITE key as well as the LOAD key.

- ③ Set the Protect switch to ON again.

When you have attempted to perform a Write operation to the RAM cartridge, a Save operation or Load operation without having inserted a RAM cartridge, the following message will appear on the LCD (The same display will also appear if the cartridge has not been inserted properly.)

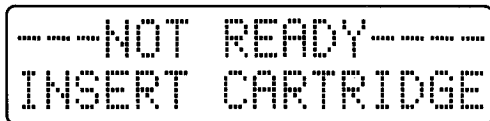

When this message appears, turn off the power and correctly insert the cartridge, then turn on the power again.

Notes on the RAM Cartridge

- The life of the battery (BR-2016) is approximately one year when it is left outside the cartridge. (When kept in the CZ unit, the battery will last longer.) If the battery shows a sign of running down, it should be replaced with a new one; otherwise, the information recorded in the cartridge may be affected. (For further details, refer to the RA-3 Operation Manual.)
- Note that replacing the battery will erase all the information recorded in the cartridge.
- The RA-3 is shipped from the factory, with the internal memory tones recorded in it for convenience of checking its quality.
- When inserting or removing the cartridge, be sure to turn off the CZ-1000.

RAM cartridge
RA-3 (option)

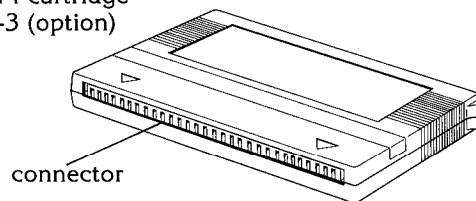

■ Parameter Section

The Parameter section is used to set all tone data for each tone. If you use the Write function, all tone data set in the Parameter section as well as line select data and modulation data can be stored in the internal memory or the cartridge memory.

• Wave Form

This parameter selects the basic wave form for each DCO. An independent WAVE FORM key is provided for each of the two DCOs (DCO 1 and DCO 2). Press one of these keys to individually select the basic wave form for the respective DCO.

As basic wave forms, any one of the wave forms 1 ~ 8 illustrated on the CZ-1000's body can be selected. In addition, you can also select a combination of 2 of these wave forms. The values for First and Second parameters correspond to the numbers of the wave forms illustrated below the LCD. (If the value for the Second parameter is set to 0, only the wave form designated by the value of First will be used.)

If you press a WAVE FORM key, the display shown in Fig. 1 will appear on the LCD and the WAVE FORM key indicator will light up.

(Fig. 1)

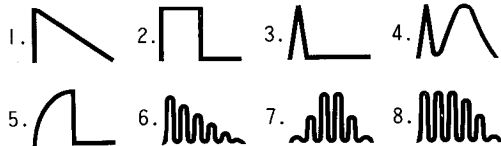
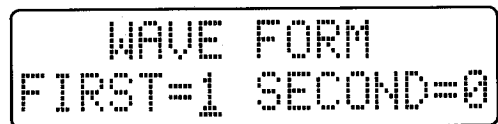

* The value for First can be set between 1 and 8, the value for Second between 0 and 8. Please note, however, that the values between 6 and 8 cannot be used simultaneously for both First and Second parameters.

In the example illustrated in Fig. 1, only the saw-tooth wave 1 has been selected. By operating the SAVE / LOAD keys in the Data Entry section, you can now set any values between 1 and 8 for the First parameter.

In order to change the Second parameter, press the CURSOR key \leftarrow to move the cursor to the value of the Second parameter and then use the VALUE key SAVE and LOAD to set the value between 0 and 8. (See Fig. 2.)

(Fig. 2)

Press the \leftarrow key.

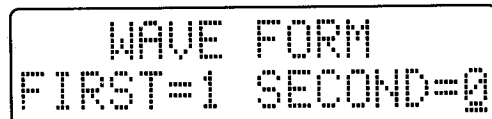

< Wave form >



press the LOAD key.

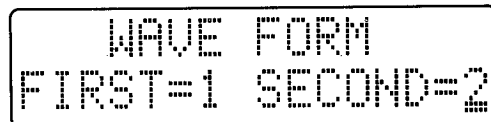

- When the parameters First and Second are both set to the same value, the effect is the same as if Second had been set to 0.
- Combining two specific different wave forms always produces the same effect regardless of which of the two wave forms is set by which parameter. If, for example, the First parameter is set to 1 and the Second to 2, the effect will be the same as if the First parameter had been set to 2 and the Second to 1.

• ENV (Envelope) Settings

Individual envelopes can be set independently for DCO 1/2, DCW 1/2 and DCA 1/2. The setting procedure, however, is the same for all.

To commence setting of the envelope parameters, first select the envelope you want to create from among those for DCO 1/2, DCW 1/2 and DCA 1/2 by pressing the corresponding ENV key. When you press an ENV key, its indicator will light up and the LCD will show the kind of display illustrated in Fig. 3.

(Fig. 3) Display after pressing the ENV key for DCO 1 or DCO 2

Indicates that step 1 of the pitch envelope has been selected.

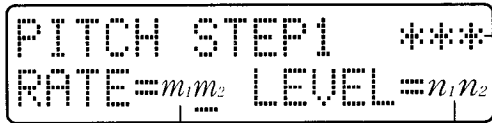

Shows the slope of the envelope's first step.

If a Sustain Point has been set in the step currently displayed, the letters 'SUS' will appear here. If an End Point has been set, this part of the display will indicate 'END'.

Shows the final level of the envelope's first step.

< Display after pressing the ENV key for DCW 1 or DCW 2 >

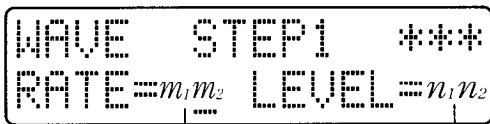

$00 \leq m_1m_2 \leq 99$

$00 \leq n_1n_2 \leq 99$

< Display after pressing the ENV key for DCA 1 or DCA 2 >

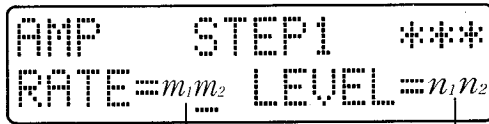

$00 \leq m_1m_2 \leq 99$

$00 \leq n_1n_2 \leq 99$

To set the parameter values for an envelope, not only the VALUE keys \square \square SAVE LOAD and CURSOR keys in the Data Entry section are used, but also the ENV STEP UP and DOWN keys as well as the ENV POINT SUSTAIN and END keys. (See Fig. 4.)

(Fig. 4)

This key decreases the Step number shown on the LCD. Pressing it when Step 1 is indicated displays the number of the step which contains the End Point.

With this key the Sustain Point is set within the envelope step currently displayed. Pressing it a second time cancels the Sustain Point setting.

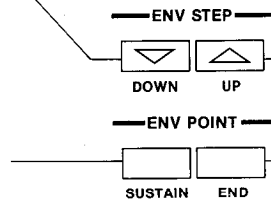

This key increases the Step number shown on the LCD. Pressing it when the step which contains the End Point is indicated returns the display to Step 1.

With this key the End Point is set within the envelope step currently displayed. When this key is pressed, the Level parameter is automatically set to 0. Pressing it again cancels the End Point setting.

In the following, we will explain how to set an ADSR envelope such as the one shown in Fig. 5 for DCA 1.

(Fig. 5)

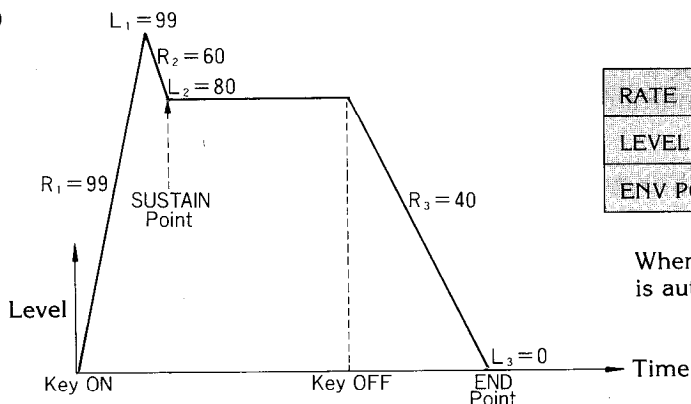

	STEP 1	STEP 2	STEP 3
RATE	99	60	40
LEVEL	99	80	00
ENV POINT	***	SUS	END

When the End Point is set, this is automatically set to 0.

① Press the DCA 1 ENV key.

```
AMP  STEP1  ***
RATE=   LEVEL=  
```

② Set the Rate value to 99 using the \downarrow UP keys.

```
AMP  STEP1  ***
RATE=99 LEVEL=  
```

$0 \leq m_1 m_2 \leq 99$
 $0 \leq n_1 n_2 \leq 99$

③ Move the cursor to the value of the Level parameter with the \square CURSOR key and set the Level value to 99 using the \square key.

```
AMP  STEP1  ***
RATE=99 LEVEL=99
```

④ Press the ENV STEP UP key to select Step 2.

```
AMP  STEP2  ***
RATE=   LEVEL=  
```

⑤ Set the Rate value to 60 using the \downarrow UP keys.

```
AMP  STEP2  ***
RATE=60 LEVEL=  
```

⑥ Move the cursor to the value of the Level parameter with the \square CURSOR key and set the Level value to 80 using the \downarrow UP key.

```
AMP  STEP2  ***
RATE=60 LEVEL=80
```

⑦ Press the ENV POINT SUSTAIN key to set the Sustain Point. (This operation is not necessary if this setting has been carried out already.)

```
AMP  STEP2  SUS
RATE=60 LEVEL=80
```

$0 \leq m_n \leq 99$
 $0 \leq k_l \leq 99$

⑧ Press the ENV STEP UP key to select Step 3.

```
AMP  STEP3  ***
RATE=   LEVEL=  
```

- ⑨ Set the Rate value to 40 using the VALUE keys ∇ Δ .

```
AMP  STEP3  ***
RATE=40 LEVEL= $n_5n_6$ 
```

- ⑩ Press the ENV POINT END key to set the End Point. (This operation is not necessary if this setting has been carried out already.)

The Level value is now automatically set to 00.

```
AMP  STEP3  END
RATE=40 LEVEL=00
```

About the Rate and Level Values

RATE

This value indicates the internal angle of the volume (DCA), tone color (DCW) and pitch (DCO) envelopes' attack (rise) and decay (fall) as opposed to a horizontal axis. 00 indicates an angle infinitely close to 0 degrees while 99 indicates one close to 90 degrees (vertical). Since these values are absolute values, they have no (+) or (-).

LEVEL

This value indicates the level up to which the volume (DCA), tone color (DCW) and pitch (DCO) envelopes rise during their attack or down to which they fall during their decay. 99 is the maximum, 00 the minimum value. In the case of the tone color (DCW) envelope, the level value 99 indicates the selected basic wave form while 00 indicates a sine wave. In the case of the pitch (DCO) envelope, the value 66 indicates a pitch raised by one octave. The pitch is further increased by one octave each according to values "66 + 6n".

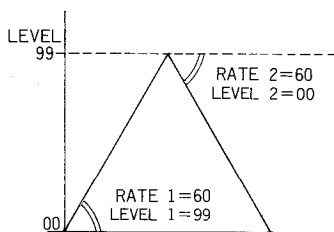

In both cases, the rate is 60.

Notes

- You cannot increase the Step number to more than the number of the step containing the End Point with the ENV STEP UP key. When you want to do so, you have to press the ENV POINT END key to cancel the End Point and then use the ENV STEP UP key. If you cancel the End Point in any of the steps 1 to 7, the End Point will be automatically set in step 8. At the same time, the data set before will be restored.
- When the Sustain Point is set for a certain step, any Sustain Point set in another step will be cancelled automatically.
- When the End Point is deleted, the data before designation of the End Point is restored.
- When the END Point is set at a certain step, the level value in that step becomes automatically 00.

• DCW Key Follow

This function changes the level (effect) of the DCW envelope according to the pitch of the sound being played. The higher the pitch of a key being pressed, the lower the level (the smaller the effect) of the envelope becomes and the closer the wave form approaches a pure sine wave.

(Fig. 6)

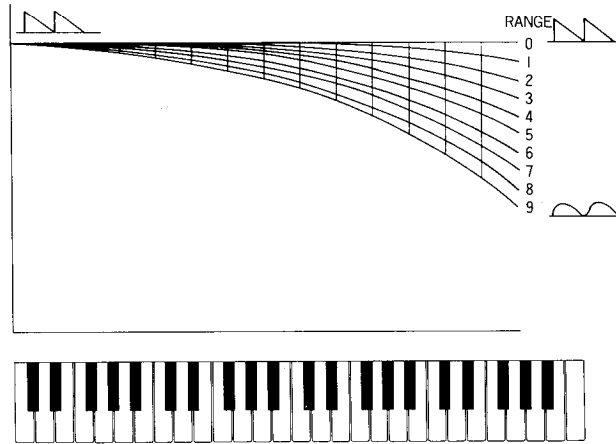

Pressing the DCW KEY FOLLOW key causes the display shown in Fig. 7 to appear on the LCD.

(Fig. 7)

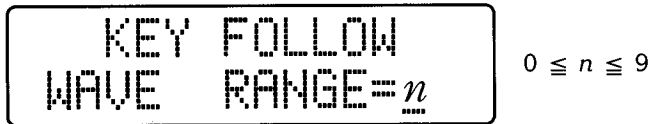

Set the Range value to between 0 and 9 using the VALUE ∇ \triangle keys.

The larger the Range value, the wider the difference in timber between the high registers and the low registers.

• DCA Key Follow

This function changes the duration of the DCA envelope according to the pitch of the sound being played. The higher the pitch of a key being pressed, the shorter the duration of the envelope becomes.

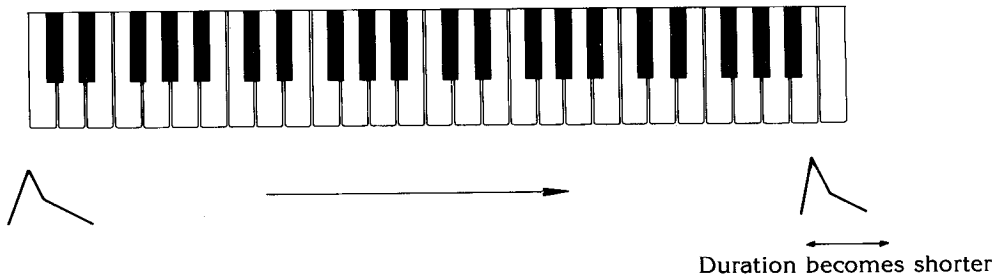

Pressing the DCA KEY FOLLOW key causes the display shown in Fig. 8 to appear on the LCD.

(Fig. 8)

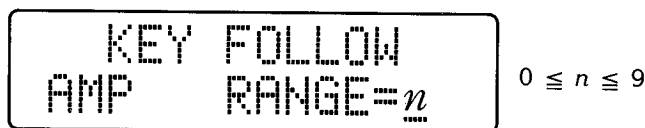

Set the Range value to between 0 and 9 using the VALUE \downarrow / \uparrow keys. The larger the Range value, the shorter the duration of the envelope becomes in the high pitch range.

• Vibrato

The vibrato parameters individually set the vibrato effect for each tone. When you press the VIBRATO key, the following display will appear on the LCD.

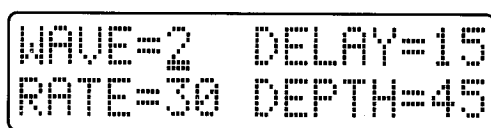

The Wave parameter selects the vibrato wave form. Use the \downarrow / \uparrow keys in the Data Entry section to select the wave form type from 1 to 4. The wave form corresponding to these Wave values are as follows.

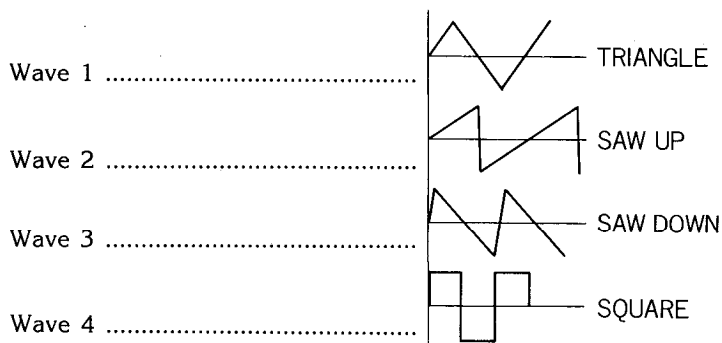

The Delay parameter determines the time it takes for the vibrato to start after a key has been pressed. Move the cursor to the position of the Delay value using the CURSOR key \rightarrow and then set the delay in the range between 0 and 99 using the \downarrow / \uparrow keys. The larger the Delay value, the longer the delay (i.e. the longer it takes for the vibrato effect to start).

The Rate parameter sets the cycle (speed) of the vibrato effect. Move the cursor to the position of the Rate value using the CURSOR key \rightarrow and then set the cycle in the range between 0 and 99 using the \downarrow / \uparrow keys. The larger the Rate value, the faster the cycle of the vibrato effect (i.e. the faster the sound seems to vibrate).

The Depth parameter sets the depth (intensity) of the vibrato effect. Move the cursor to the position of the Depth value using the CURSOR key \rightarrow and then set the depth in the range between 0 and 99 using the \downarrow / \uparrow keys. The larger the Depth value, the more stronger the vibrato effect.

• Octave

This parameter moves the pitch range of a tone up or down by one octave. When you press the OCTAVE key, the following display will appear on the LCD.

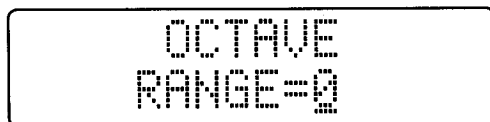

Use the $\overline{\text{SAVE}}/\overline{\text{LOAD}}$ keys in the Data Entry section to set the Range value to +1, 0 or -1.

* In the initial tone data stored in the preset and internal memories, the Range values are set differently according to the individual tone.

• Detune

This function lets you detune (alter the pitch) of a DCO within a range of ± 4 octaves. Detune is used e.g. to create a pitch difference between DCO 1 and DCO 2 when they have different tones, or simply to detune the pitch of DCO 1 only and mix it with the DCO 1 sound that has not been detuned for a chorus effect. The detuned sound of Line 1 (DCO 1) is called Line 1 while the detuned sound of Line 2 (DCO 2) is called Line 2.

If you press the DETUNE key, the display shown in Fig. 9 will appear on the LCD. (The cursor will be positioned at the value of the OCT parameter.)

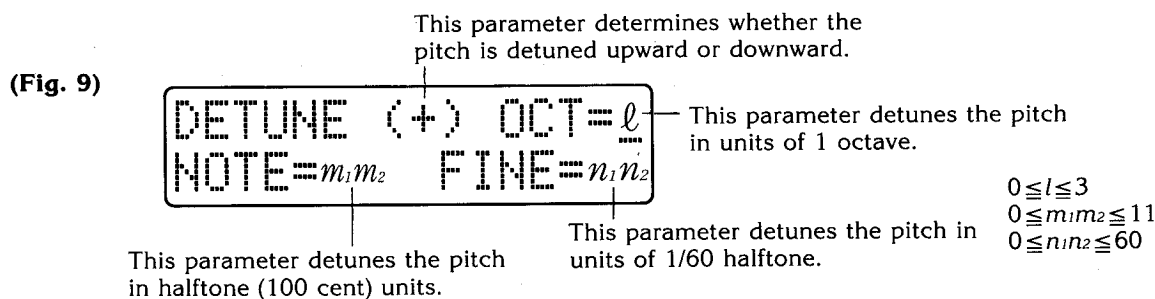

Next, the various parameter values are set. To be able to monitor the extent of the detune effect, however, first perform one of the operations explained below according to the DCO you are detuning.

- To confirm detuning of Line 1
Press the LINE SELECT key to select $\boxed{1+1}$. (The respective indicator will light up.)
 - To confirm detuning of Line 2
Press the LINE SELECT key to select $\boxed{1+2}$. (The respective indicator will light up.)
- * You cannot monitor Line 1 or Line 2 alone.

(a) Determining the detune direction

Move the cursor under the desired polarity indicator (\oplus or \ominus) with the CURSOR keys and use the $\overline{\text{SAVE}}/\overline{\text{LOAD}}$ keys to set \oplus if you want to detune the pitch upward, \ominus if you wish to detune the pitch downward.

(b) Detuning in 1 octave units

Move the cursor under the value of the OCT parameter with the CURSOR keys and use the $\overline{\text{SAVE}}/\overline{\text{LOAD}}$ keys to set a value between 0 and 3. The pitch will then be detuned upward or downward in 1 octave units by up to 3 octaves.

(c) Detuning in 1 halftone (100 cent) units

Move the cursor under the value of the NOTE parameter with the CURSOR keys and use the $\overline{\text{SAVE}}/\overline{\text{LOAD}}$ keys to set a value between 0 and 11. The pitch will then be detuned upward or downward in halftone (100 cent) units by up to 11 halftones.

(d) Fine detuning

Move the cursor under the value of the FINE parameter with the CURSOR keys and use the $\overline{\text{SAVE}}/\overline{\text{LOAD}}$ keys to set a value between 0 and 60. The pitch will then be detuned upward or downward in units of 1/60 half-tone (1.7 cents) by up to 1 half-tone.

* When all three parameters OCT, NOTE and FINE are set to 0, Line $\boxed{1}$ = Line $\boxed{1}$, Line $\boxed{2}$ = Line $\boxed{2}$.

• Line Select

This function allows you to select the Line combination best suited to the kind of sound you are creating. When storing data in the internal memory or cartridge memory with the Write function, the Line Select data is memorized along with the tone data.

Pressing the LINE SELECT key repeats selection in the order $\boxed{1} \rightarrow \boxed{2} \rightarrow \boxed{1+2} \rightarrow \boxed{1+1}$.

• When Line Select is set to $\boxed{1}$

This position is excellent for creating simple sounds. The CZ-1000 operates as an 8-voice polyphonic synthesizer with this setting.

• When Line Select is set to $\boxed{2}$

This position is used to monitor Line $\boxed{2}$ when using the Line combination $\boxed{1+2}$.

• When Line Select is set to $\boxed{1+2}$

This position is ideal for creating sounds with a complicated harmonics structure. If the three detune parameters OCT, NOTE and FINE are all set to 0, the effect is the same as $\boxed{1} + \boxed{2}$. In this setting, the CZ-1000 operates as a 4-voice polyphonic synthesizer.

• When Line Select is set to $\boxed{1+1}$

This position is very effective when you want to create "spacy" sounds with ensemble or chorus effects. In this setting, the CZ-1000 operates as a 4-voice polyphonic synthesizer. If the three detune parameters OCT, NOTE and FINE are all set to 0, the effect is the same as $\boxed{1} + \boxed{1}$, but the CZ-1000 then operates as a 4-voice polyphonic synthesizer.

• Ring Modulation

When you press the RING key, its indicator will light up and Line $\boxed{1}$ or Line $\boxed{2}$ will be ring modulated by Line $\boxed{1}$. Pressing the RING key again cancels this function. The ring modulation function will operate only if Line Select is set to $\boxed{1+2}$ or $\boxed{1+1}$.

Ring modulation is ideal for creating clangorous sounds such as bells, etc.

* Ring modulation output is created by the multiplication of musical sounds, thus causing non-integral harmonics. The musical sounds created in this manner will thus often seem to be out of tune.

• Noise Modulation

When you press the NOISE key, its indicator will light up and Line $\boxed{1}$ or Line $\boxed{2}$ will be modulated by noise. Pressing the NOISE key again cancels this function.

The ring modulation function will operate only if Line Select is set to $\boxed{1+2}$ or $\boxed{1+1}$.

* The RING key and NOISE key cannot be used at the same time.

When extreme settings have been made in the parameter section, it can happen that no sound is produced at all since the range of possible sounds has been exceeded.

• Initialize

This function allows you to reset all parameters practically to their initial settings to enable free sound creation.

To initialize a parameter, keep the INITIALIZE key pressed and then press the key corresponding to the parameter you want to initialize.

Example: Initializing the DCW 1 envelope

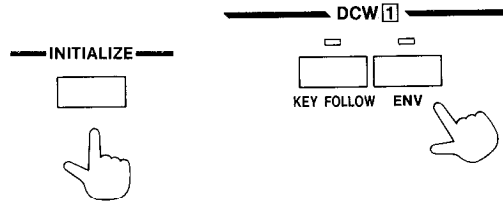

Press the DCW 1 ENV key while pressing the INITIALIZE key.

The data of each initialized parameter is shown below.

Parameter	Initialized data																
VIBRATO	WAVE = 1, DELAY = 00, RATE = 00, DEPTH = 00																
OCTAVE	RANGE = 0																
WAVE FORM (DCO 1, DCO 2)	FIRST = 1 SECOND = 0																
PITCH ENVELOPE (DCO 1, DCO 2)	<table border="1"> <thead> <tr> <th></th> <th>STEP 1</th> <th>STEP 2~7</th> <th>STEP 8</th> </tr> </thead> <tbody> <tr> <td>RATE</td> <td>50</td> <td>50</td> <td>50</td> </tr> <tr> <td>LEVEL</td> <td>00</td> <td>00</td> <td>00</td> </tr> <tr> <td>ENV POINT</td> <td>SUS</td> <td>***</td> <td>END</td> </tr> </tbody> </table>		STEP 1	STEP 2~7	STEP 8	RATE	50	50	50	LEVEL	00	00	00	ENV POINT	SUS	***	END
	STEP 1	STEP 2~7	STEP 8														
RATE	50	50	50														
LEVEL	00	00	00														
ENV POINT	SUS	***	END														
DCW KEY FOLLOW	RANGE = 0																
WAVE ENVELOPE (DCW 1, DCW 2)	<table border="1"> <thead> <tr> <th></th> <th>STEP 1</th> <th>STEP 2~7</th> <th>STEP 8</th> </tr> </thead> <tbody> <tr> <td>RATE</td> <td>99</td> <td>50</td> <td>50</td> </tr> <tr> <td>LEVEL</td> <td>99</td> <td>00</td> <td>00</td> </tr> <tr> <td>ENV POINT</td> <td>SUS</td> <td>***</td> <td>END</td> </tr> </tbody> </table>		STEP 1	STEP 2~7	STEP 8	RATE	99	50	50	LEVEL	99	00	00	ENV POINT	SUS	***	END
	STEP 1	STEP 2~7	STEP 8														
RATE	99	50	50														
LEVEL	99	00	00														
ENV POINT	SUS	***	END														
DCA KEY FOLLOW	RANGE = 0																
AMP ENVELOPE (DCA 1, DCA 2)	<table border="1"> <thead> <tr> <th></th> <th>STEP 1</th> <th>STEP 2~7</th> <th>STEP 8</th> </tr> </thead> <tbody> <tr> <td>RATE</td> <td>99</td> <td>50</td> <td>50</td> </tr> <tr> <td>LEVEL</td> <td>99</td> <td>00</td> <td>00</td> </tr> <tr> <td>ENV POINT</td> <td>SUS</td> <td>***</td> <td>END</td> </tr> </tbody> </table>		STEP 1	STEP 2~7	STEP 8	RATE	99	50	50	LEVEL	99	00	00	ENV POINT	SUS	***	END
	STEP 1	STEP 2~7	STEP 8														
RATE	99	50	50														
LEVEL	99	00	00														
ENV POINT	SUS	***	END														
DETUNE	OCTAVE = 0, NOTE = 00, FINE = 00																

* The data for the various parameters are set to values that enable the easiest kind of operations when creating new tones.

■ Effect Section

• Bend Range

① Press the BEND RANGE key.



② Set the Range value to between 0 and 12 using the ∇ / \triangle keys.

- * The Bend Range setting determines the width of the pitch bend possible when using the pitch bend wheel. It can be set in the range from 0 (no pitch bend effect at all) to 12 (pitch bend width of ± 1 octave).
- * The Bend Range setting has the same effect for all tones.

• Vibrato

Pressing the VIBRATO ON/OFF key sets the vibrato effect to on/off. The indicator lights up when it is on. The vibrato effect set individually for each tone in the Parameter section is activated by this key.

This key will be automatically set to on when a tone for which a vibrato has been set is selected in the Programmer section.

- * If the vibrato Depth parameter has been set to 0, the VIBRATO key is automatically set to off and the indicator goes out.

• Portamento

The portamento function of the CZ-1000 differs from the portamento on a conventional analog synthesizer in that a fixed glide time can be set regardless of pitch difference — a very practical feature for actual performance.

(Fig. 1)

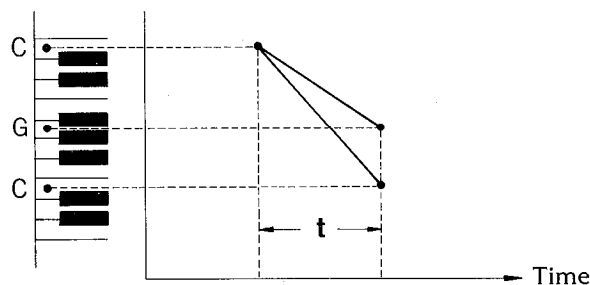

As shown in Fig. 1, a portamento glide from C to G takes the same time t as a portamento glide from C to the C one octave above.

• **Setting the portamento time**

Press the PORTAMENTO TIME key and set the Time value between 0 and 99 with the ∇/\triangle keys. The larger the value, the longer the portamento (glide) time.

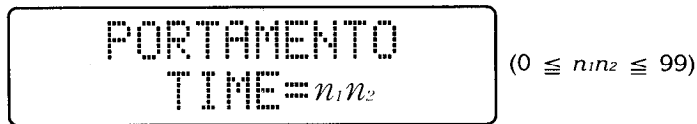

• **Portamento ON/OFF**

Each time the PORTAMENTO ON/OFF key is pressed, the portamento effect is switched between on and off.

* When the SOLO key or the TONE MIX key are set to on, the CZ-1000 operates as a monophonic synthesizer. In this monophonic mode, the portamento effect will only be obtained with a legato playing style. (i.e. when the following note is played while the first one is still being held).

• **SOLO key**

When you want to play your CZ-1000 as a monophonic synthesizer, press the SOLO key. Only one note can now be played at a time, and the note played last will sound.

* Pressing the SOLO key when the TONE MIX key is set to on cancels the Tone Mix function.

• **Tone Mix**

Pressing the TONE MIX key lets you mix any 2 tones of your choice. (The keyboard then becomes monophonic.)

* Pressing the TONE MIX key when the SOLO key is set to on cancels the Tone Mix function.

(Example) Mix the tone of preset no. 1 with the internal memory tone no. 9.

① Recall the preset tone no. 1.

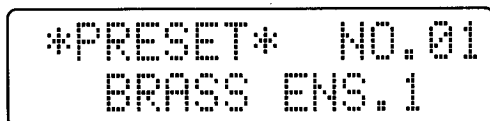

② Press the TONE MIX key to turn on the Tone Mix function.

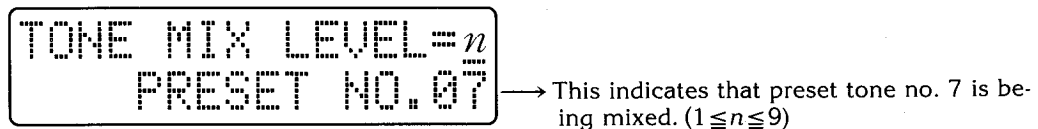

③ Press the INTERNAL Memory key.

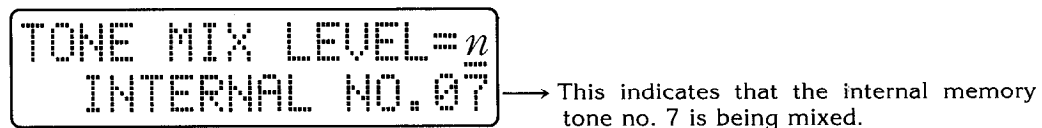

- ④ Press the tone selector no. 1.

TONE MIX LEVEL= n
INTERNAL NO. 01

→ This indicates that the internal memory tone no. 1 is being mixed.

→ This value changes regardless of the cursor position.

- ⑤ Press the SELECT key.

TONE MIX LEVEL= n
INTERNAL NO. 09

→ This indicates that the internal memory tone no. 9 is being mixed.

* When using the Tone Mix function, watch the LC display to confirm the selection of the tones being mixed.

- ⑥ Use the ∇ / \triangle keys in the Data Entry section to set the level (volume) of the internal memory tone no. 9.

TONE MIX LEVEL= n
INTERNAL NO. 09

→ Tone mix level n can be set in 9 stages.

* The level value sets the volume of the sound selected after pressing the Tone Mix key (in this example, internal sound no. 9) as opposed to the sound selected before the Tone Mix key was pressed (in this example, preset sound no. 1). The maximum value is 9, in which case the volume level of both sounds will be identical.

• Key Transpose

After pressing the KEY TRANSPOSE key, use the ∇ / \triangle keys in the Data Entry section to determine the key you want to transpose to.

KEY TRANSPOSE
KEY=C

→ Can be set from G to F#.

* The initial data of the preset and internal memories are all set to "C".

■ MIDI

The MIDI (Musical Instrument Digital Interface) standard is a generally accepted standard for the external control of electronic instruments. You can connect your CZ-1000 to any equipment provided with MIDI terminals, even products not made by CASIO. The CZ-1000 can transmit and receive the following kinds of data through MIDI cables.

Message	Transmit	Receive
Key pitch and on/off data	○	○
VIBRATO ON/OFF	○	○
PORTAMENTO TIME		○
MASTER TUNE		○
PORTAMENTO ON/OFF	○	○
TONE NUMBER DATA	○	○
PITCH BEND DATA	○	○
LOCAL CONTROL OFF		○
MONO MODE		○
POLY MODE		○
END OF SYSTEM EXCLUSIVE	○	○

SYSTEM EXCLUSIVE

Message	Transmit	Receive
SEND REQUEST 1 *Note 1		○
RECEIVE REQUEST *Note 2		○
BEND RANGE DATA		○
KEY TRANSPOSE DATA		○
TONE MIX DATA		○
SEND REQUEST 2 *Note 3		○

* Note 1:

When the CZ-1000 receives a send request 1 message, it will transmit tone data.

* Note 2:

When the CZ-1000 receives a receive request 1 message, it will receive and store the data of one tone that is transmitted immediately afterwards.

* Note 3:

When the CZ-1000 receives a send request 2 message, it will send data indicating the present programmer and effects settings, etc.

• Connection examples

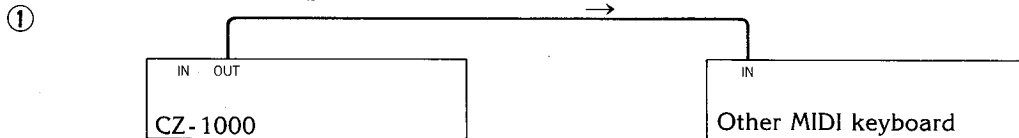

This connection lets you enjoy remote control.

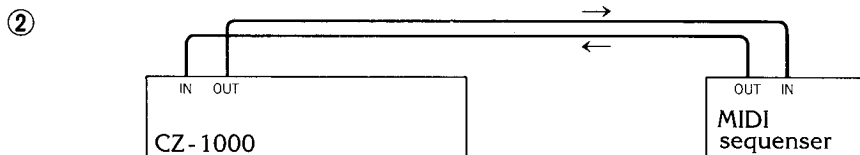

With this connection, you can enjoy automatic performance.

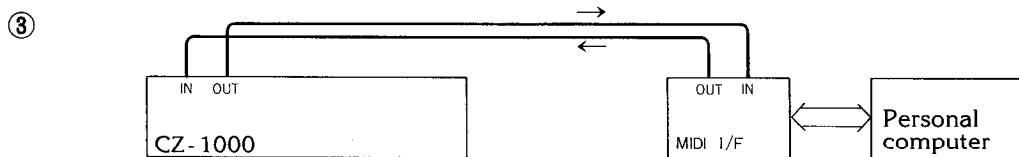

Using different kinds of computer software, you can enjoy your CZ-1000 in a great variety of ways.

• **Setting the Transmit and Receive Modes**

When transmitting or receiving data according to the MIDI standard, it is necessary to match the channel number of the transmitting unit with that of the receiving unit. In the Poly mode (that is the mode when the SOLO key is set to off), the CZ-1000 operates as a polyphonic synthesizer transmitting and receiving data on any of 16 channels. In Mono mode (when the SOLO key is set to on), it will receive data for controlling 4 independent monophonic synthesizer voices on any 4 of the 16 channels having the numbers N, N + 1, N + 2 and N + 3. (Transmission is performed on any one of the channels N to N + 3.)

* When the Tone Mix function is on, the CZ-1000 is played as a monophonic synthesizer, but the MIDI settings correspond to the Poly mode.

• **Poly mode**

Setting the channel for reception/transmission in Poly mode (with the SOLO key set to off) Pressing the MIDI key when the SOLO key is off, the message shown in Fig. 1 will be displayed.

(Fig. 1)

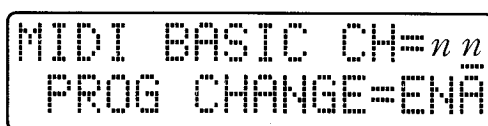

$1 \leq nn \leq 16$ "ENA" or "DIS"

Using the VALUE keys ($\overline{\text{SAVE}}$ $\overline{\text{LOAD}}$) set the channel number to any value from 1 to 16. The data of anything performed on the CZ-1000 will then be sent to other MIDI equipment on the selected channel, while only data transmitted on the selected channel will be received by the CZ-1000. When the lower line of the display indicates "PROG CHANGE = ENA", data concerning the tone numbers can be transmitted or received. (ENA = enable)

If you press the $\overline{\text{SAVE}}$ or $\overline{\text{LOAD}}$ key after having moved the cursor to the lower line with the CURSOR keys, the display will change to "PROG CHANGE = DIS" (DIS = disable). In this mode, data concerning the tone numbers cannot be transmitted or received. To return the display to "PROG CHANGE = ENA", simply press the $\overline{\text{SAVE}}$ or $\overline{\text{LOAD}}$ key again.

• **Mono mode**

Setting the channel for reception/transmission in Mono mode (with the SOLO key set to on) Pressing the MIDI key when the SOLO key is on, the message shown in Fig. 2 will be displayed.

(Fig. 2)



$1 \leq nn \leq 16$

$nn \leq mm \leq nn + 3$

In this mode, the CZ-1000 functions in a manner similar to 4 independent monophonic synthesizers played at the same time. This means that 4 channels of data with independent tones can be received and played simultaneously.

If the basic channel for reception is set to any channel N among the 16 available channels in Mono mode, channels N, N + 1, N + 2 and N + 3 become the 4 voice channels. If differing tones are selected and independent vibrato and portamento on/off settings made for each of the 4 channels, these data are received on the respective channels and the four voices are played with different tones and effects.

• How to set the number of the basic channel

Using the VALUE keys (\square SAVE \square LOAD), set the channel number to any value from 1 to 16.

• How to set the tones and switch the effects on/off according to the voice channels

Using the CURSOR keys, move the cursor to the position of the "VO" value. By pressing the \square SAVE or \square LOAD key, you can set the voice channel numbers to N, N + 1, N + 2 and N + 3, N being the basic channel number.

After having set the "VO" value to N using the \square SAVE key, select the tone using the Programmer section and set vibrato and portamento to on/off in the Effect section. Next, set the voice channel number to N + 1 with the \square LOAD key, and then select the tone and effects as described above. Repeat this procedure for voice channels N + 2 and N + 3.

Anything you play on the CZ-101 keyboard will be transmitted on the voice channel indicated on the LC display.

* If you have set the basic channel number to 14 or over, 2 voices or more will be assigned to channel 16. Since no more than 1 voice can be used per channel, the remaining voices will not be heard at all.

The "ENA" and "DIS" PROG CHANGE settings are performed in the same manner as in Poly mode.

• Using a MIDI Sequencer

Provided here is an example of the procedure you should follow when creating an automatic 4-tone orchestral performance using the CZ-1000 in mode 4 (Omni-Off/Mono Mode). It is assumed that you are using a sequencer with a minimum of four tracks or a device with equivalent functions.

- ① Use MIDI cables to connect the CZ-1000's MIDI IN terminal to the sequencer's MIDI OUT terminal, and the CZ-1000 MIDI OUT terminal to the sequencer's MIDI IN terminal. (See page 37: "Connection examples" ②.)
- ② Turn the SOLO key on and press the MIDI key.
- ③ Set the basic channel to CH=01 at the Data Entry section, and confirm the setting in the LC Display. (See Fig. A)

(Fig. A)

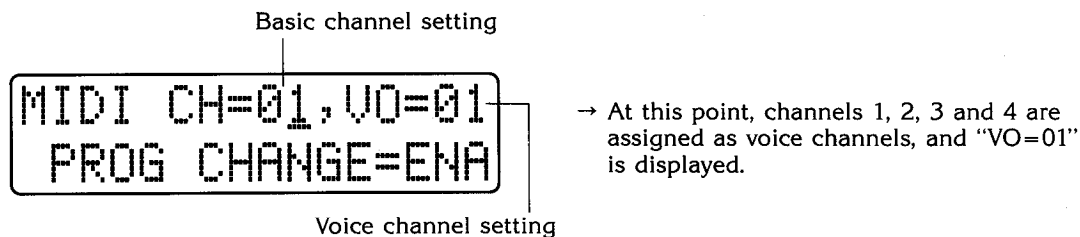

- ④ Set the tones for each of the four voice channels and use the sequencer to record the parts for each channel. (The table below gives an example of parts for four voices.)

Voice Channel	Part	Tone	Portamento
01	BASS	SYNTH. BASS	OFF
02	OBLIGATO	SYNTH. STRING 2	OFF
03	PERCUSSION	PERCUSSION	OFF
04	MELODY	TRUMPET	ON

(1) Set voice channel	(2) Set tone (using programmer section)	(3) Perform and record each part (using sequencer)
VO = 01 →	PRESET No. 8 →	Perform/record bass part
VO = 02 →	INTERNAL No. 13 →	Perform/record obligato part
VO = 03 →	PRESET No. 16 →	Perform/record percussion part
VO = 04 →	PRESET No. 2 (Portamento on) (Time 08)	Perform/record melody part

⑤ When the sequencer's playback function is activated, the CZ-1000 automatically performs the four-part melody recorded using the procedure outlined above.

Note: A personal computer equipped with an appropriate interface can also be used instead of a sequencer. (See page 37: "Connection examples"③.)

■ Care of Your Unit

1. Please be careful of extreme temperatures, moisture and direct sunlight.

Please avoid using or storing your CZ-1000 in places subject to direct sunlight, excessively moist places or near air conditioning and heating appliances where temperatures and moisture tend to be extreme.

2. Please do not drop this instrument or subject it to strong shocks.

Subjecting this precision instrument to strong shocks may cause malfunctioning, so please be very careful. When carrying the CZ-1000 with you or transporting it, please protect it properly with shock-absorbant packaging, in particular the keyboard and switches.

3. Make sure no foreign matter gets into the inside of this instrument.

Please take care that no foreign objects, especially metal objects such as hair pins, sewing needles or coins gets into the instrument e.g. through the gaps between the keys. Also make sure no water or other fluids get in. Any metal objects or water entering the instrument can cause malfunctioning as well as an electric shock hazard.

4. Customizing may cause malfunction and accidents.

The CZ-1000 uses many high-precision electronic components. Converting it in any manner or carelessly touching the internal parts may cause malfunction and accidents and should therefore be avoided under all circumstances.

5. Please do not use thinner and similar chemicals when cleaning this instrument.

When cleaning your CZ-1000, use a soft cloth dampened with a neutral detergent solution which has been wrung out completely to wipe the keyboard etc. Use of thinner, alcohol, benzene and similar chemicals should be avoided under all circumstances.

6. Insert and remove cartridges only when power has been turned off.

When using cartridges, please be sure to turn off the power when inserting or removing them in order to protect the memorized tones.

■ Specifications

Model:	Casio Digital Synthesizer CZ-1000
Keyboard:	49 keys/4 octaves (standard keys)
Sound source:	PD (Phase Distortion) Sound Source System
Voices:	8 (using 1 DCO) or 4 (using 2 DCOs)
Tone memories (preset):	Bank of 16 (PRESET)
Tone memories (programmable):	Bank of 16 (INTERNAL)
External RAM memories:	Bank of 16 (CARTRIDGE option)
Compare area:	1 (COMPARE/RECALL)
Programmer section:	PRESET, INTERNAL, CARTRIDGE, COMPARE/RECALL, TONE SELECT 1~16
Data Entry Section:	VALUE (<input type="checkbox"/> /SAVE, <input type="checkbox"/> /LOAD), CURSOR (<input type="checkbox"/> , <input type="checkbox"/>), LCD (= Liquid Crystal Display: DOT MATRIX: 16x2)
Parameter section:	ENVELOPE STEP (DOWN, UP), ENVELOPE POINT (SUSTAIN, END), INITIALIZE, VIBRATO (WAVE = 1 ~ 4, DELAY = 0 ~ 99, RATE = 0~99, DEPTH = 0~99), OCTAVE (RANGE = -1, 0, +1) DCO 1/DCO 2 • WAVE FORM (FIRST=1~5→SECOND=0~8, FIRST=6~8→SECOND=0~5) • ENVELOPE GENERATOR/PITCH (STEP = 1~8, RATE = 0~99, LEVEL = 0~99) DCW 1/DCW 2 • KEY FOLLOW (WAVE RANGE = 0~9) • ENVELOPE GENERATOR/WAVE (STEP = 1~8, RATE = 0~99, LEVEL = 0~99) DCA 1/DCA 2 • KEY FOLLOW (AMP RANGE = 0~9) • ENVELOPE GENERATOR/AMPLITUDE (STEP = 1~8, RATE = 0~99, LEVEL = 0~99) DETUNE (OCT = 0~3, NOTE = 0~11, FINE = 0~60), LINE SELECT (1, 2, 1+2', 1+1') MODULATION (RING, NOISE)
Effect section:	PITCH BEND, BEND RANGE (RANGE = 0~12), VIBRATO ON/OFF, PORTAMENTO TIME (TIME = 0~99), PORTAMENTO ON/OFF, SOLO, TONE MIX (LEVEL = 1~9), KEY TRANSPOSE (G~F [#])
Connection terminals:	LINE OUT, PHONES, DC9V, MIDI (IN/OUT) * Output impedance = 1.5 kΩ, Output voltage = 1.2 V (RMS) max.
Power supply:	3 power sources * Household power supply AC 100, 117, 220 or 240V (±10V) using AC adaptor (AD-5, option) * Car battery using Car adaptor (CA-5, option) * Dry batteries: 6 x D-size (Also serves as memory back-up power supply.) Battery life: approx. 5 hrs. (using SUM-1) (memory-back-up: 1 year)
Auto Power OFF function:	Becomes effective about 7 minutes after last operation to turn power off automatically: APO ON/OFF
Memory Protect function:	Prevents loss of data due to spent batteries (turns power off automatically): PROTECT ON/OFF

Turning control:	± 100 cents (\pm approx. 1 halftone)
Power consumption:	5.4 W
Dimensions:	785(W) x 300(D) x 90(H)mm (32"(W) x 12 ¹ / ₄ "(D) x 3 ⁵ / ₈ "(H))
Weight:	5.5 kg (including batteries)
Supplied accessories:	Plug cord set, 6 (SUM-1) batteries.

** Design and specifications are subject to change without notice.*

**GUIDELINES LAID DOWN BY FCC RULES FOR USE OF THE UNIT IN THE U.S.A.
(not applicable to other areas).**

This equipment generates and uses radio frequency energy and if not installed and used properly, that is, in strict accordance with the manufacturer's instructions, may cause interference to radio and television reception. It has been type tested and found to comply with the limits for a Class B computing device in accordance with the specifications in Subpart J of Part 15 of FCC Rules, which are designed to provide reasonable protection against such interference in a residential installation. However, there is no guarantee that interference will not occur in a particular installation. If this equipment does cause interference to radio or television reception, which can be determined by turning the equipment off and on, the user is encouraged to try to correct the interference by one or more of the following measures:

- reorient the receiving antenna
 - relocate the computer with respect to the receiver
 - move the computer away from the receiver
 - plug the computer into a different outlet so that computer and receiver are on different branch circuits.
- If necessary, the user should consult the dealer or an experienced radio/television technician for additional suggestions. The user may find the following booklet prepared by the Federal Communications Commission helpful: "How to Identify and Resolve Radio-TV Interference Problems". This booklet is available from the US Government Printing Office, Washington, D.C., 20402, Stock No. 004-000-00345-4.

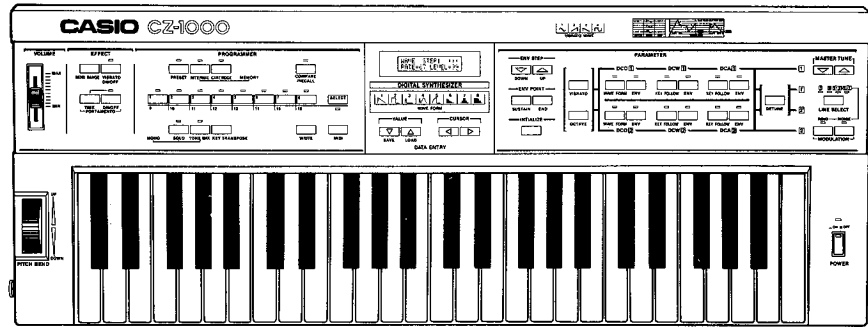

CASIO®