

 Roland

MIDI

DIGITAL EFFECTS PROCESSOR DEP-5

Owner's Manual



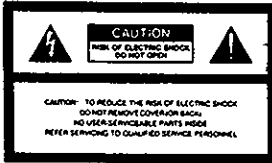

The lightning flash with arrowhead symbol, within an equilateral triangle, is intended to alert the user to the presence of un-insulated "dangerous voltage" within the product's enclosure that may be of sufficient magnitude to constitute a risk of electric shock to persons.

The exclamation point within an equilateral triangle is intended to alert the user to the presence of important operating and maintenance (servicing) instructions in the literature accompanying the product.

INSTRUCTIONS PERTAINING TO A RISK OF FIRE, ELECTRIC SHOCK OR INJURY TO PERSONS.

IMPORTANT SAFETY INSTRUCTIONS

WARNING When using electric products, basic precautions should always be followed, including the following:

1. Read all the instructions before using the product.
2. To reduce the risk of injury, close supervision is necessary when a product is used near children.
3. Do not use this product near water- for example, near a bathtub, washbowl, kitchen sink, in a wet basement, or near a swimming pool, or the like.
4. This product should be used only with a cart or stand that is recommended by the manufacture.
5. This product, either alone or in combination with an amplifier and headphones or speakers, may be capable of producing sound levels that could cause permanent hearing loss.
Do not operate for a long period of time at a high volume level or at level that is uncomfortable. If you experience any hearing loss or ringing in the ears, you should consult an audiologist.
6. The product should be located so that its location or position does not interfere with its proper ventilation.
7. The product should be located away from heat sources such as radiators, heat registers or other products that produce heat.
8. The product should avoid using in where it may be effected by dust.
9. The product should be connected to a power supply only of the type described in the operating instructions or as marked on the product.
10. The power-supply cord of the product should be unplugged from the outlet when left unused for a long period of time.
11. Do not tread on the power-supply cord.
12. Do not pull the cord but hold the plug when unplugging.
13. When setting up with any other instruments, the procedure should be followed in accordance with instruction manual.
14. Care should be taken so that objects do not fall and liquids are not spilled into the enclosure through openings.
15. The product should be serviced by qualified service personnel when:
 - A: The power-supply cord or the plug has been damaged; or
 - B: Objects have fallen, or liquid has been spilled into the product; or
 - C: The product has been exposed to rain; or
 - D: The product does not appear to operate normally or exhibits a marked change in performance; or
 - E: The product has been dropped, or the enclosure damaged.
16. Do not attempt to service the product beyond that described in the user-maintenance instructions. All other servicing should be referred to qualified service personnel.

SAVE THESE INSTRUCTIONS

ADVARSEL!

Lithiumbatteri. Eksplosionsfare.
Udsiktning må kun foretages af en sagkyndig,
og som beskrevet i servicemanual.

VARNING!

Lithiumbatteri. Explosionsrisk.
Får endast bytas av behörig servicetekniker.
Se instruktioner i servicemanualen.

ADVARSEL!

Lithiumbatteri. Fare for eksplosion.
Må bare skiftes av kvalifisert tekniker som
beskrevet i servicemanualen.

VAROITUS!

Lithiumparisto. Rajahdysvaara.
Pariston saa vaihtaa ainoastaan
alan ammottimies.

WARNING

THIS APPARATUS MUST BE EARTH GROUNDDED.

The three conductors of the mains lead attached to this apparatus are identified with color as shown in the table below, together with the matching terminal on the UK type power plug. When connecting the mains lead to a plug, be sure to connect each conductor to the correct terminal, as indicated.
"This instruction applies to the product for United Kingdom."

MAINS LEADS		PLUG
Conductor	Color	Mark on the matching terminal
Live	Brown	Red or letter L
Neutral	Blue	Black or letter N
Grounding	Green-Yellow	Green, Green-Yellow, letter E or symbol

Bescheinigung des Herstellers /Importeurs

Hiermit wird bescheinigt, daß der/die/das
ROLAND DIGITAL EFFECTS PROCESSOR DEP-5
(Germ. Typ. Bezeichnung)

in Übereinstimmung mit den Bestimmungen der
Amtsbl. Vfg 1046 / 1984
(Amtsblattverfügung)

funk-entstört ist.
Der Deutschen Bundespost wurde das Inverkehrbringen dieses Gerätes
angezeigt und die Berechtigung zur Überprüfung der Serie auf Einhaltung
der Bestimmungen eingeräumt.

Roland Corporation Osaka / Japan

Name des Herstellers/Importeurs

RADIO AND TELEVISION INTERFERENCE

"Warning - This equipment has been verified to comply with the limits for a Class B computing device, pursuant to Subpart J, of Part 15, of FCC rules. Operation with non-certified or non-verified equipment is likely to result in interference to radio and TV reception."

The equipment described in this manual generates and uses radio-frequency energy. If it is not installed and used properly, that is, in strict accordance with our instructions, it may cause interference with radio and television reception.
This equipment has been tested and found to comply with the limits for a Class B computing device in accordance with the specifications in Subpart J, of Part 15, of FCC Rules. These rules are designed to provide reasonable protection against such a interference in a residential installation. However, there is no guarantee that the interference will not occur in a particular installation. If this equipment does cause interference to radio or television reception, which can be determined by turning the equipment on and off, the user is encouraged to try to correct the interference by the following measure:

- Disconnect other devices and their input/output cables one at a time. If the interference stops, it is caused by either the other device or its I/O cable. These devices usually require Roland designated shielded I/O cables. For Roland devices, you can obtain the proper shielded cable from your dealer. For non-Roland devices, contact the manufacturer or dealer for assistance.
 - If your equipment does cause interference to radio or television reception, you can try to correct the interference by using one or more of the following measures:
 - Turn the TV or radio antenna until the interference stops.
 - Move the equipment to one side of the other of the TV or radio.
 - Move the equipment farther away from the TV or radio.
 - Plug the equipment into an outlet that is on a different circuit than the TV or radio. (That is, make certain the equipment and the radio or television set are on circuits controlled by different circuit breakers or fuses.)
 - Consider installing a rooftop television antenna with coaxial cable lead-in between the antenna and TV.
- If necessary, you should consult your dealer or an experienced radio/television technician for additional suggestions. You may find helpful the following booklet prepared by the Federal Communications Commission:
"How to Identify and Resolve Radio-TV Interference Problems"
This booklet is available from the U.S. Government Printing Office, Washington, D.C., 20462. Stock No. 004-000-00345-4.

Please read the separate volume "MIDI", before reading this owner's manual.

Copyright © 1986 by ROLAND CORPORATION

All rights reserved. No part of this publication may be reproduced in any form without the written permission of ROLAND CORPORATION.

1 PANEL DESCRIPTION

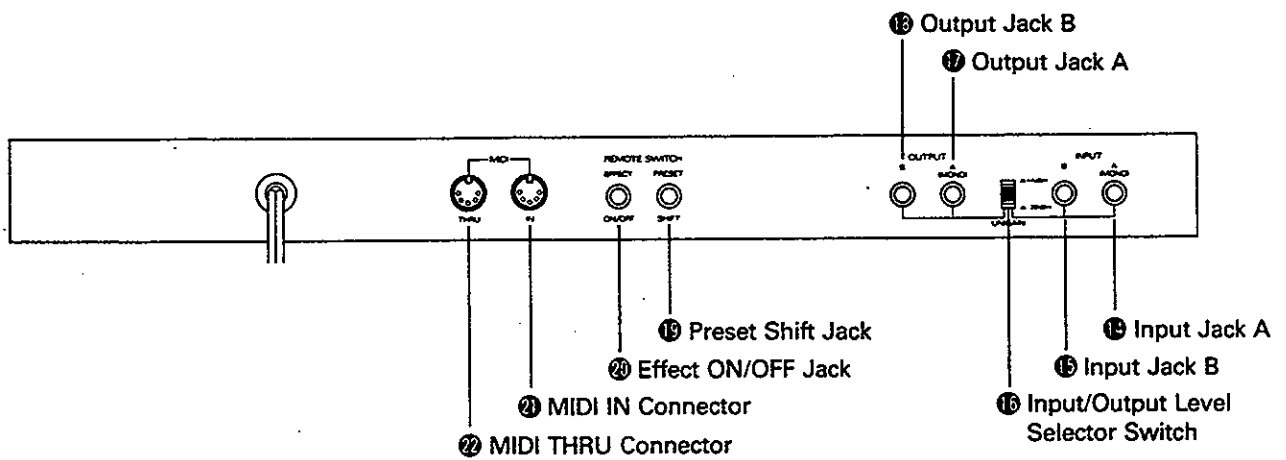
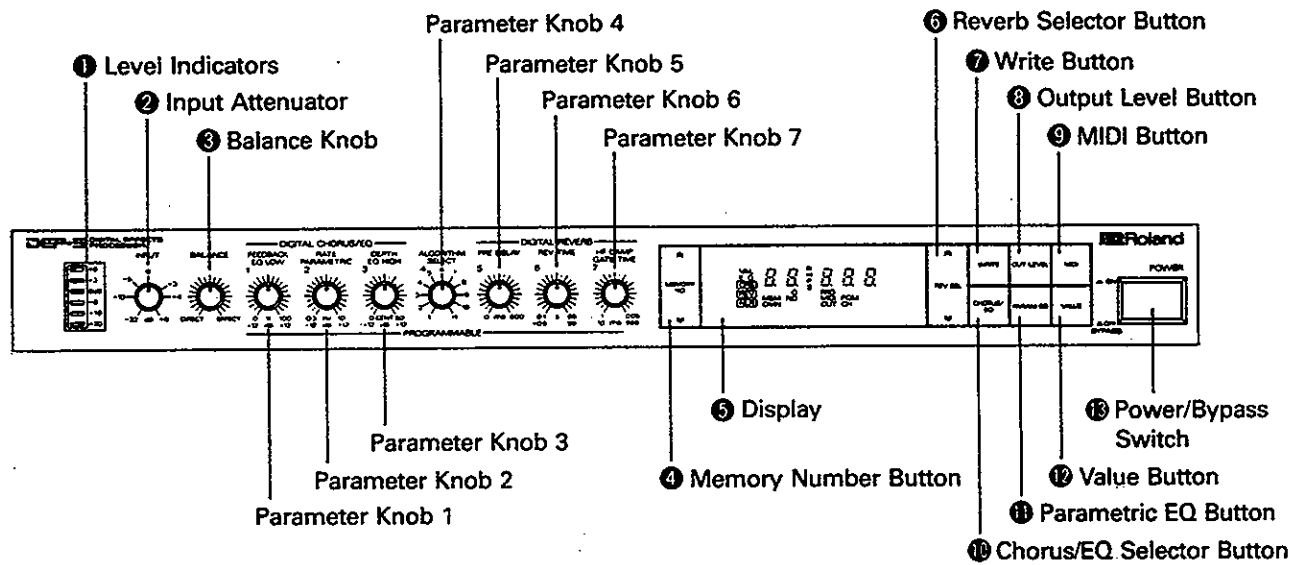

CONTENTS

1	PANEL DESCRIPTION	3	3.	Writing into Memory	34
2	OUTLINE OF THE DEP-5	5	4.	Remote Control	37
3	BASIC OPERATION	8	5	SELECTING EFFECT SETTINGS WITH MIDI	38
1.	Connection	8	6	MEMO	43
2.	Operation	9	7	SPECIFICATIONS	48
a.	Level Setting	9			
b.	Recalling the Factory Preset Effects	10			
4	GENERAL OPERATION	11			
1.	Connection	11			
2.	Programming and Editing	12			
a.	Algorithm Selection	12			
b.	Editing Parameters	17			
1)	Chorus	19			
2)	Reverb	21			
3)	Non-linear	24			
4)	Dealy	27			
5)	Equalizer	29			
6)	Output Level/Balance	32			

IMPORTANT NOTES

- Please use the appropriate line voltage which is shown on the name plate.
- This unit may be heated while operating, but there is nothing to worry about.
- Avoid using the unit in extreme heat, humidity or where it may be affected by dust.
- Use mild detergent for cleaning. Do not use solvents such as thinner.
- Please avoid placing or dropping anything heavy on the power cable.
- Operating the unit near a neon or fluorescent lamp may cause noise interference. If so, change the angle of the unit.
- If the unit is not to be used for a long period of time, unplug the cord from the socket.
- * Please do not pull the cord but hold the plug when unplugging.
- The unit may not operate properly if turned on immediately after turned off. If this happens, simply turn it off, then turn it on again in about five seconds.
- Please do not disassemble the unit even when it breaks down.
- About seven seconds after the unit is turned on, the muting and bypass circuits function and no effect sound is heard.
- The DEP-5 features memory back-up system that retains the data even when switched off. The battery that supports the back-up circuit should be replaced every five years. Call for the Roland service station for the battery replacement. (The first replacement may be required before five years, depending on how long it had passed before you purchased the unit.)

2 OUTLINE OF THE DEP-5

The DEP-5 is a versatile effect unit that features Non-linear Reverb (Gate Reverb) and Delay effects as well as the Reverb and Chorus. Moreover, using the Algorithm function, these effects can be spontaneously combined creating subtle effects.

- Digital Reverbs include four types of effects: Room, Hall, Plate and Special: altogether 22 different reverberation effects. And more, Gate Reverb can be obtained in the Non-linear mode.
- The Digital Chorus creates more natural chorus effect than the analog chorus.
- The maximum delay time of the DEP-5 is 2000ms.
- Up to 99 different effect settings can be written into memory.
- Three Band Digital Equalizer is built in.
- Featuring MIDI Connectors, the DEP-5 can be set up with other MIDI device. The Program Change message sent from the external device can select the effect setting on the DEP-5.
- The DEP-5 adopts the 16 bit A/D/A conversion system and 28 bit internal arithmetic digital signal processor, allowing dynamics range of 90dB and total harmonic distortion of under 0.03%.

Flowchart of the DEP-5

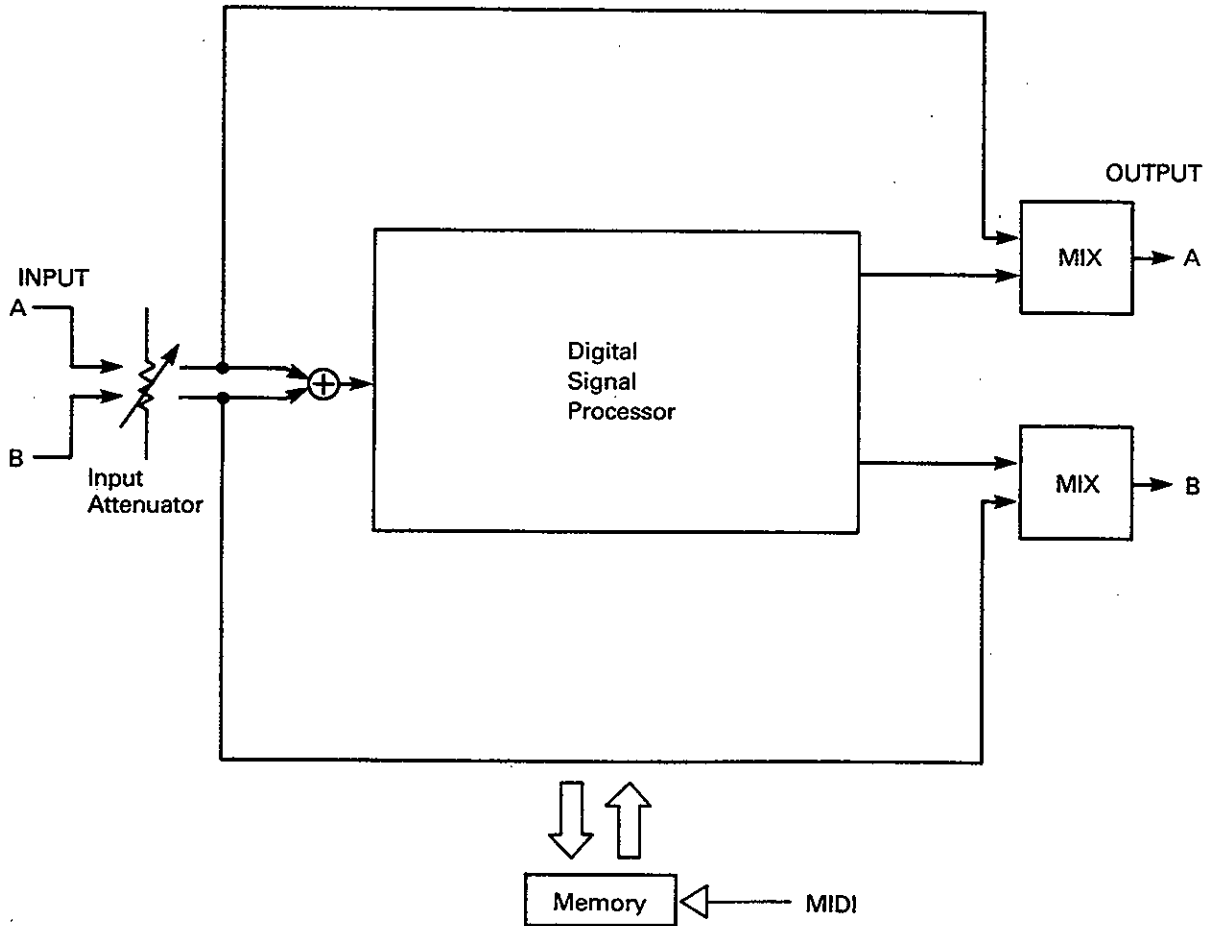

- The signal sent through the Input Jack goes to the Input Attenuator then to the Digital Signal Processor. The Input Attenuator serves to adjust the level of the signal before sending it to the Digital Signal Processor.
- At the Digital Signal Processor, the frequency response of the signal is altered by the 3 Band Equalizer. Then, processed with 28 bit parallel arithmetic digital processor, and comes out in the final form (effect sound).
- The effect sound is finally mixed with the direct sound.
- The DEP-5 features the memory capacity that retains 99 different effect settings which can be recalled easily by using the buttons on the panel or by using the MIDI Program Change message sent from the external device.

ABOUT REVERBERATION

Reverberation, different from the direct sound that reaches you directly from the sound source, reaches your ears after reflecting here and there. For example, when a musical instrument is played in a hall, even after the instrument stops giving sound, there is remaining sound in the hall for a while. This is the reverberation.

* The picture below will help understand what reverberation is.

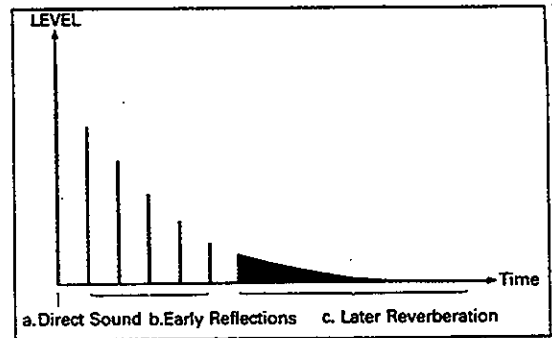

a. Direct Sound

The sound reaches your ears directly from the sound source. Naturally, this is heard first.

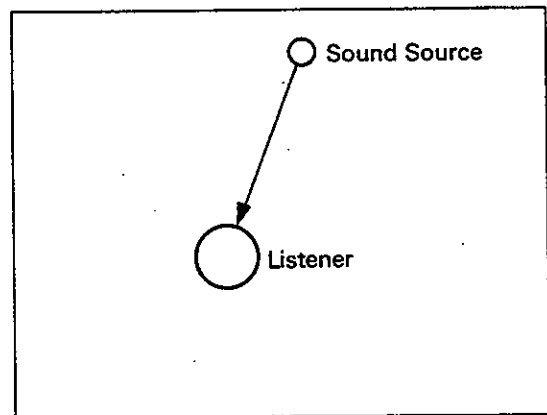

b. Early Reflections

The sound reaches your ears after reflected by the wall or ceiling once.

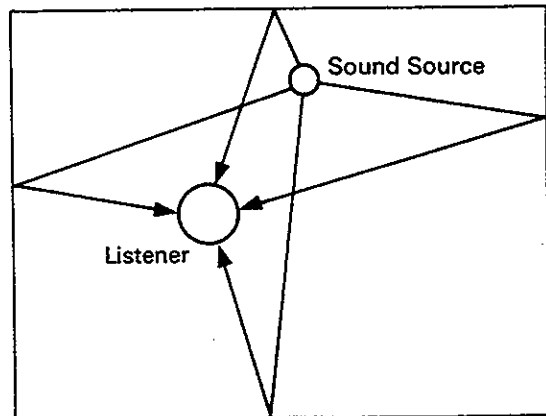

c. Later Reverberation

The sound comes after reflected many times in various phases and from various directions.

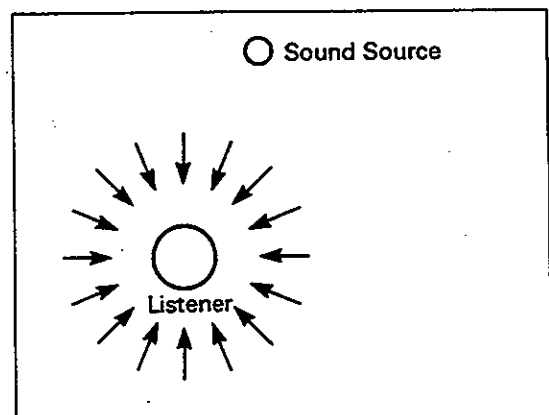

3 BASIC OPERATION

1. Connection

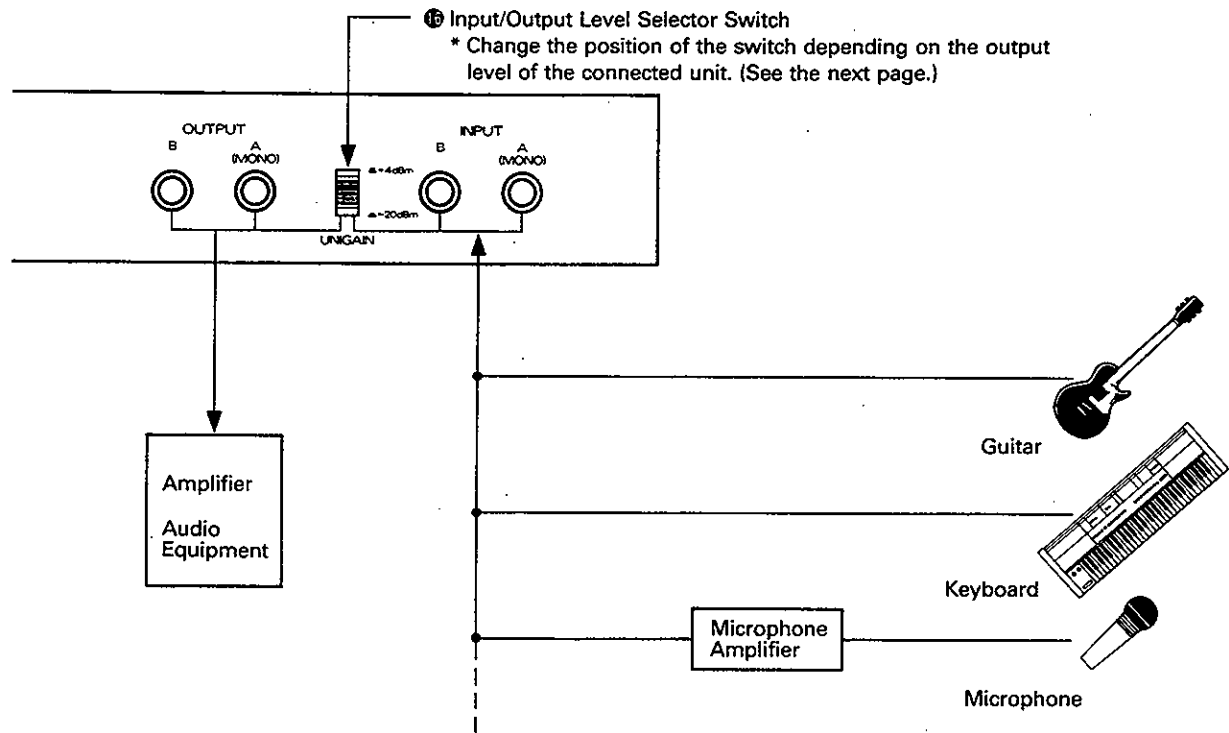

2. Operation

■ Power/Bypass Switch

The Power/Bypass Switch ⑬ serves both as a power switch and bypass on/off switch. That is, when this switch is turned off, the device connected to the Input Jack ⑭ or ⑮ and the one connected to the Output Jack ⑰ or ⑱ have direct connection.

a. Level Setting

When you have completed to set up the DEP-5 with other devices, set the level of the DEP-5 as follows so that there will be the least noise and distortion.

* Once the level is set, you do not have to change it unless the output level of the device connected to the Input Jack is drastically changed.

PROCEDURE

- ① Set the Input/Output Selector Switch ⑩ depending on the output level of the device connected to the Input Jack ⑭ and/or ⑮.

+ 4dBm: Roland Rack System
Professional Audio Equipment.

-20dBm: Electronic Musical Instrument such
as synthesizer.
Consumer-type Audio Equipment,
etc.

- ② Set the Input Attenuator where "3dB" and "6dB" of the Level Indicators light up at the highest volume. If you cannot manage to do it, change the volume of the device connected to the Input Jack.

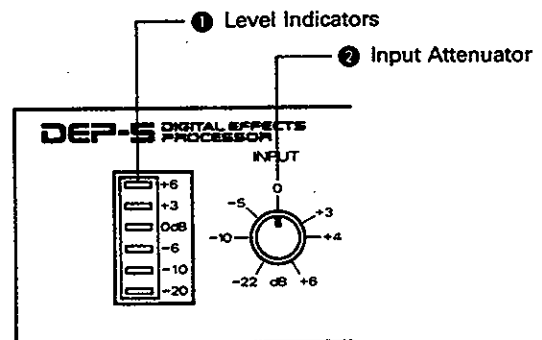

- * If you still cannot make the appropriate indicators light up, change the position of the Input/Output Level Selector Switch, and repeat the step ②.
- * If you still does not succeed, use a pre-amplifier between the DEP-5 and the connected device.
- ③ Finally, adjust the volume of the device connected to the Output Jack ⑪ and/or ⑫.

b. Recalling a Preprogrammed Effect

The DEP-5's memory capacity can retain up to 99 effect settings, and 99 different effects are pre-programmed from the manufacturer. To call any of the factory programmed effects, use the Memory Number (Up and Down) Button ④. (See the separate booklet "Example Settings".)

- * Pushing \wedge side increases the number and \vee side decreases. The Memory number currently selected is shown at the right of the Display Window.

Whenever necessary, adjust the volume of the device connected to the Output Jack.

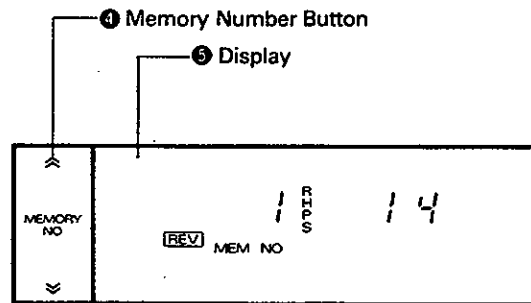

4 GENERAL OPERATION

1. Connection

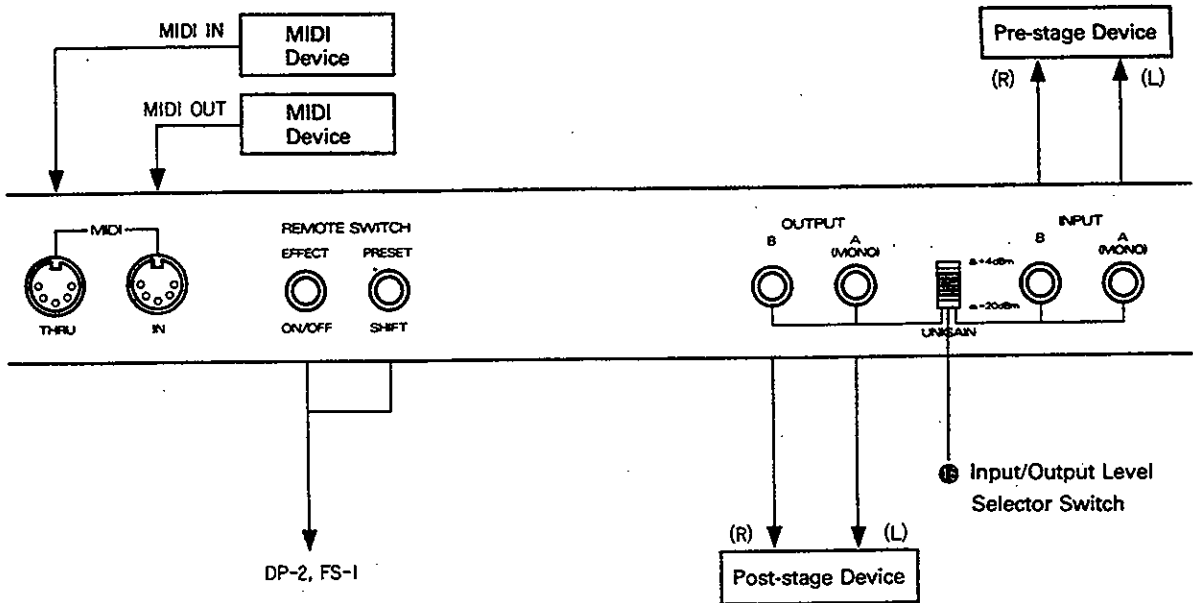

[Setting Examples]

<Electric Guitar>

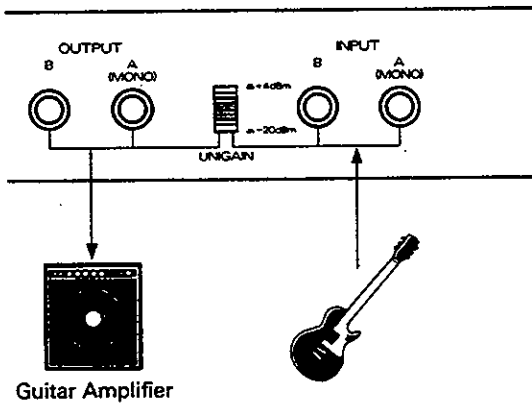

<Keyboard>

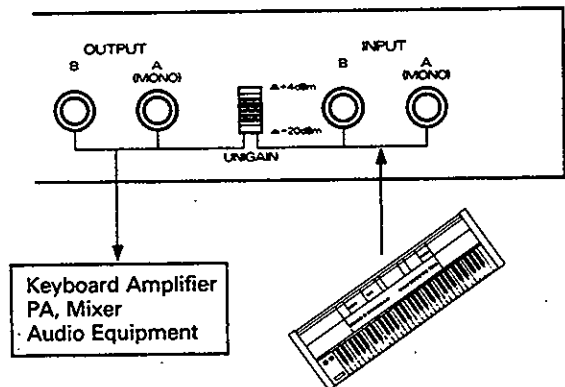

<Microphone>

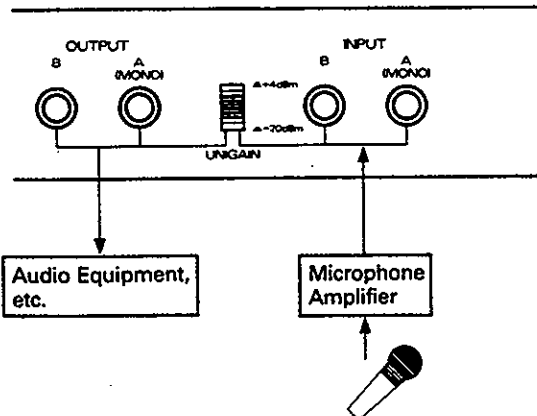

<PA, Mixer>

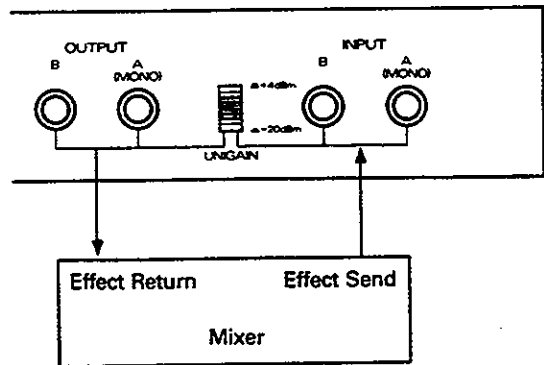

2. Programming and Editing

After taking the procedure of "a. Level Setting" on page 9, you can program (or edit) the effect setting.

First of all, select a Memory number you like. If you choose the Memory number where no data is written, you will have to program from scratch. To save your time and work, it may be a good idea to select a Memory number which is somehow similar to the effect you wish to program, modify it and write it into memory.

* The knobs on the panel do not affect the effect setting you have recalled from memory. To see the parameter values of the effect setting you have recalled, take the procedure shown on page 33.

a. Algorithm Selection

Algorithm is combination of the parameters. There are eleven algorithms optional by using the Parameter Knobs.

* The Display ⑤ will show the Parameter Knob number of the Algorithm (4) at the left side and the Algorithm number currently selected at the right for about half a second.

* When selecting an Algorithm, the effect sound will be muted for a moment, but this is nothing to worry about.

■ Algorithm 1

Chorus effect only.

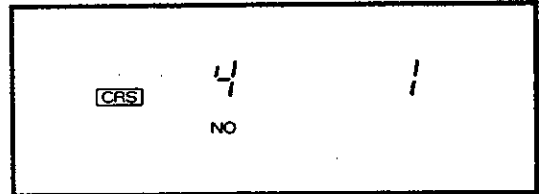
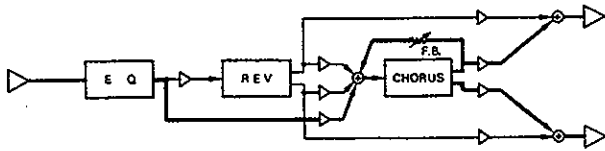

■ Algorithm 2

Reverb effect only.

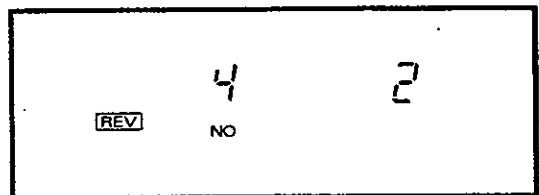
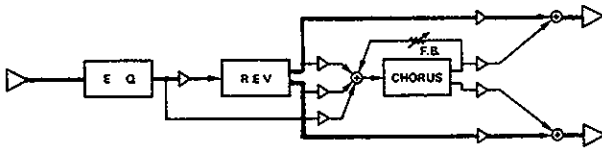

■ Algorithm 3

Reverb with Modulation.

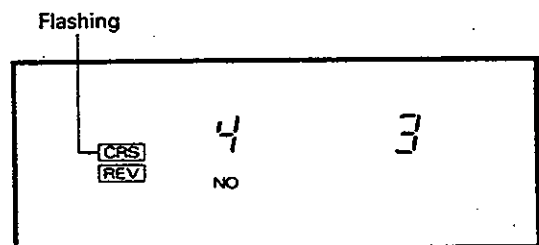
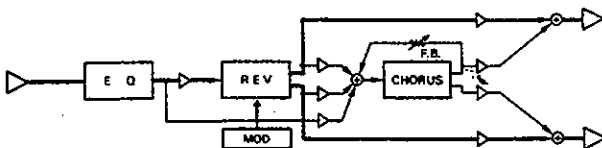

■ **Algorithm 4**

Chorus effect on Reverb.

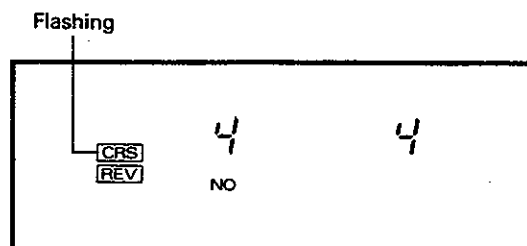
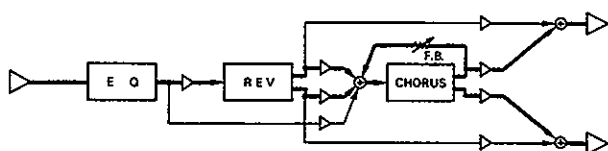

■ **Algorithm 5**

Reverb and Chorus in parallel.

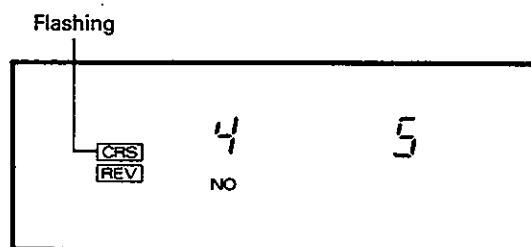
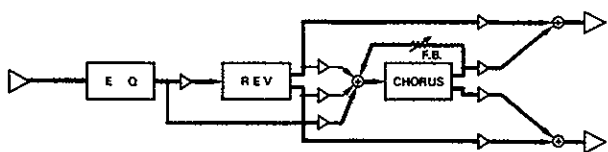

■ **Algorithm 6**

Reverb and Chorus in series and in parallel (with more amount of chorus than Algorithm 5).

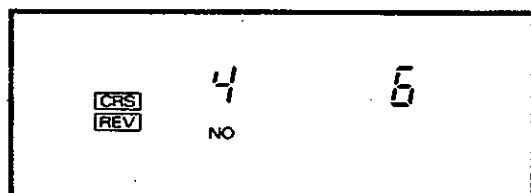
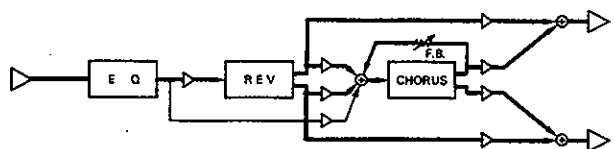

■ Algorithm 7

Non-linear Reverb only.

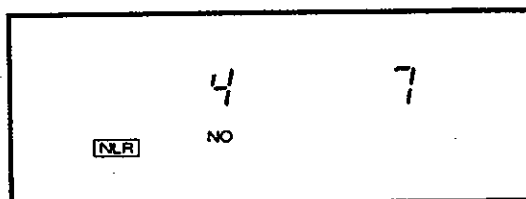
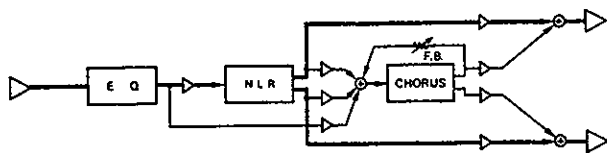

■ Algorithm 8

Non-linear Reverb with Modulation.

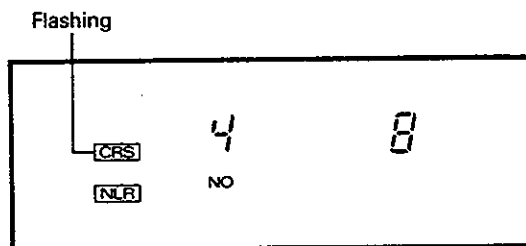
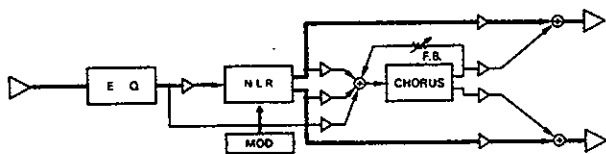

■ Algorithm 9

Non-linear Reverb and Chours in series and in parallel.

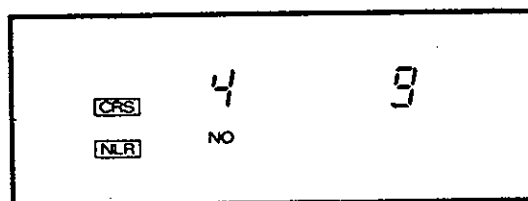
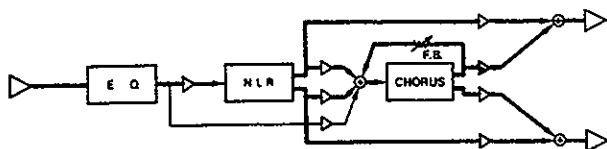

■ Algorithm 10

Chorus and Delay in parallel.

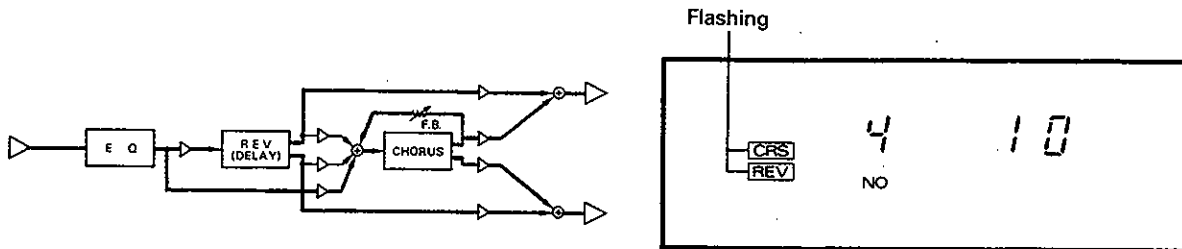

■ Algorithm 11

Non-linear Reverb of low density with Modulation.

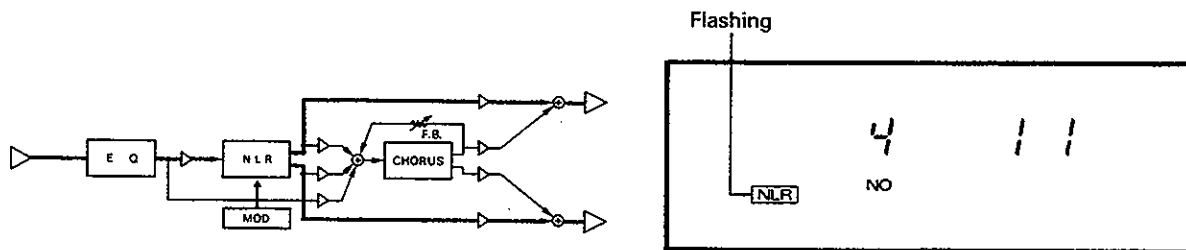

b. Editing Parameters

Now, you may edit each parameter of the selected Algorithm. Usually use the Parameter Knobs 1 to 3 and 5 to 7 and occasionally the Memory Number Button ④ and the Reverb Selector Button ⑥. Pushing the upper side of the button will advance a number, and the lower side will back up a number. Also, pressing one side while holding the other side down will quicken the change.

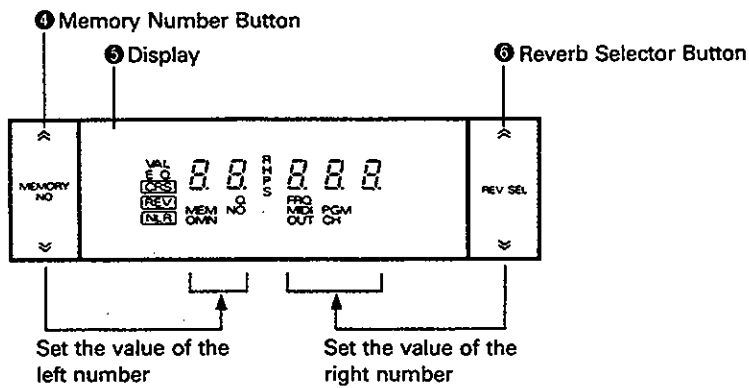

* When you set the value of the parameter with the Parameter Knob, the Display will show the value at the right for half a second. (The number shown at the left of the Display is the Parameter Knob number.)

Some Algorithm contains all the parameters, and some do not. See the table shown below.

Algorithm	Chorus (Modulation)			Reverb			Non-Linear			Delay			Equalizer					
	FEEDBACK (Parameter Knob 1)	RATE (Parameter Knob 2)	DEPTH (Parameter Knob 3)	PRE DELAY (Parameter Knob 5)	REV TIME (Parameter Knob 6)	HF DAMP (Parameter Knob 7)	REV SELECT (Reverb Selector Button)	PRE DELAY (Parameter Knob 5)	DRY TIME (Parameter Knob 6)	OUTPUT (Reverb Selector Button)	DELAY TIME (Parameter Knob 5)	FEEDBACK (Parameter Knob 6)	HF DAMP (Parameter Knob 7)	DW PUT (Reverb Selector Button)	EQ LOW (Parameter Knob 1)	PARAMETRIC (Parameter Knob 2)	EQ HIGH (Parameter Knob 3)	Q (Memory Number Button)
1	○	○	○											○	○	○	○	○
2				○	○	○	○							○	○	○	○	○
3		○	○	○	○	○	○							○	○	○	○	○
4	○	○	○	○	○	○	○							○	○	○	○	○
5	○	○	○	○	○	○	○							○	○	○	○	○
6	○	○	○	○	○	○	○							○	○	○	○	○
7							○	○	○	○				○	○	○	○	○
8		○	○				○	○	○	○				○	○	○	○	○
9	○	○	○				○	○	○	○				○	○	○	○	○
10	○	○	○							○	○	○	○	○	○	○	○	○
11		○	○				○	○	○	○				○	○	○	○	○

* The Parameter Knobs 1, 2, 3, 5 and 6 have two functions and the Parameter Knob 7 has three functions.

1) Chorus (Modulation)

Before setting the parameters of Chorus, make sure that "EQ" is not lit in the Display. (When the Display shows "EQ", the DEP-5 is in the mode of setting Equalizer parameters.) If "EQ" is shown in the Display, push the Chorus/EQ Selector Button ⑩ to change to the Chorus parameter setting mode.

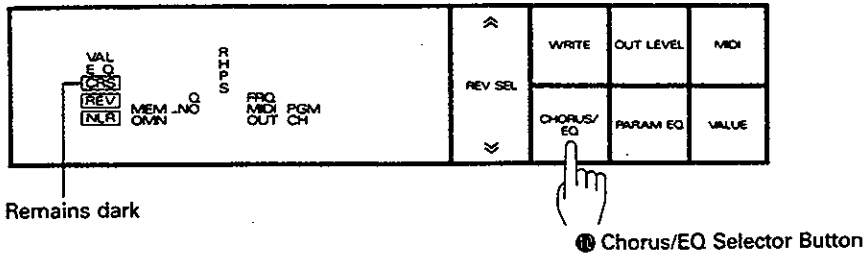

• FEEDBACK

Using the Parameter Knob 1, set the amount of the Feedback.

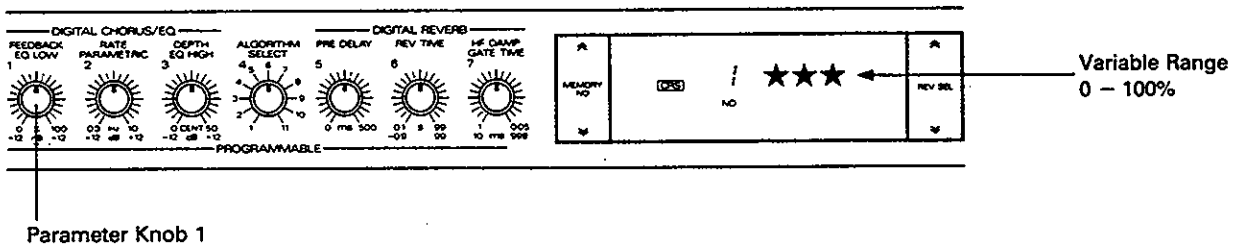

• Modulation Rate

Using the Parameter Knob 2, set the speed of the Modulation.

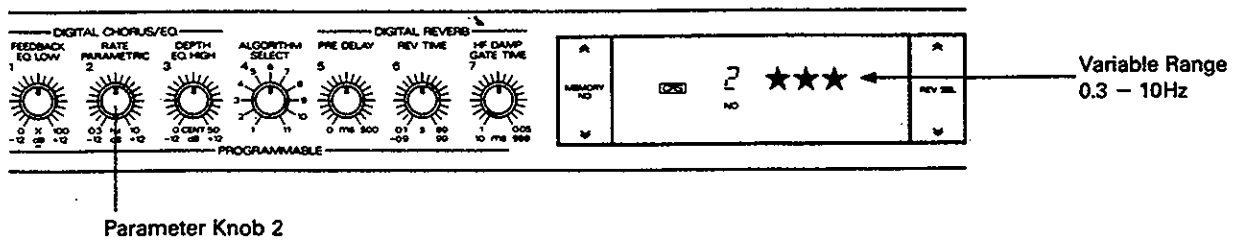

• **Modulation Depth**

Using the Parameter Knob 3, set the depth of the Modulation.

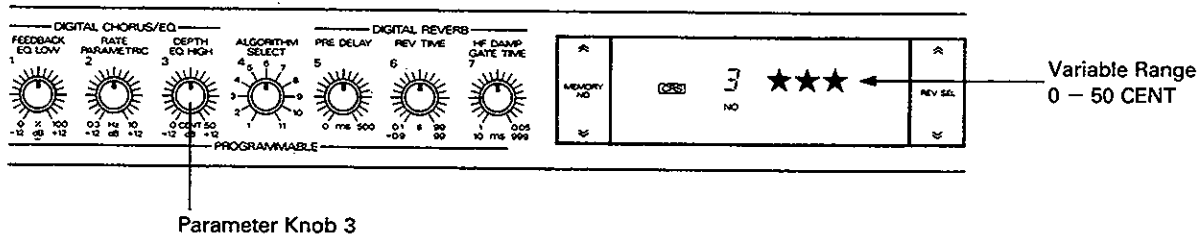

* When setting the value of the Modulation Depth and Rate, you may hear click noise, but there is no need to worry about it.

2) Reverb

• REVERB SELECT

Using the Reverb Selector Button **⑥**, select any of the following four Reverb effects.

• Room

ROOM is a sharp, expansive and rich reverberation of high reverb density.

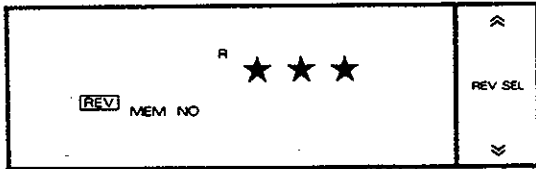

• Hall

HALL is a deeper reverberation of low reverb density.



• Plate

PLATE is bright and metallic reverb which is ideal for percussive sound.

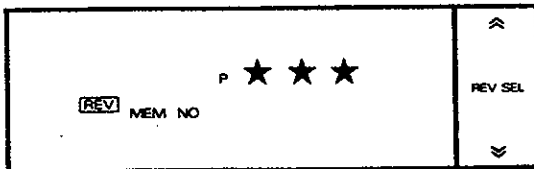

• Special

SPECIAL is a fantastic reverb sound.

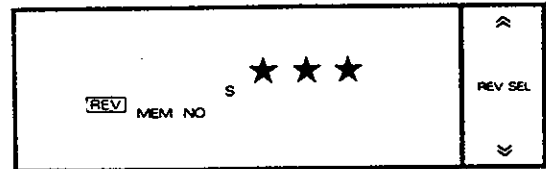

Each time you push the Reverb Selector Button **⑥**, the four Reverbs will be sequentially called.

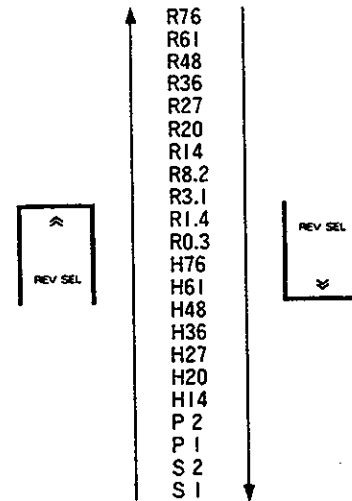

* When ROOM or HALL is selected, the number shown in the right side of the Display represents the size of the room. The room here, however, is considered to be a cube, therefore, the number represents the side of a cube (meter).

* Each of PLATE and SPECIAL has two types of the reverberations: P1, P2, S1, S2.

* When selecting a Reverb, the effect sound is muted for a moment, but there is no need to worry about it.

• **PRE-DELAY**

The number shown here is the time elapsed between the direct sound and the later reverberation (ms). That is, this shows the depth of the room (or hall). Increasing the pre-delay time will make a deeper room.

With the Parameter Knob 5, you can change the pre-delay time.

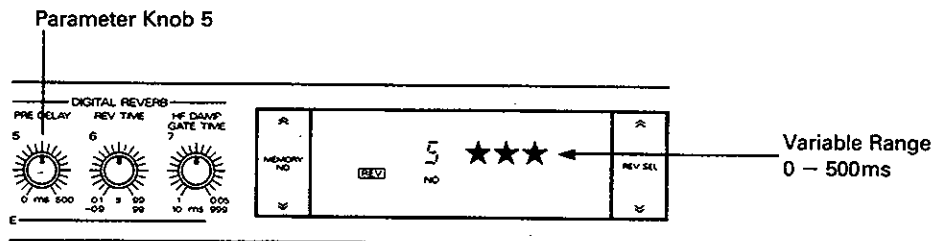
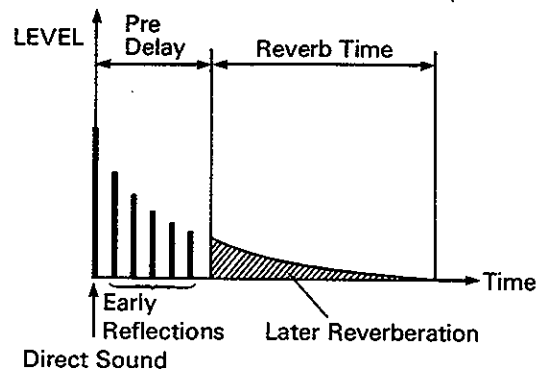

* When changing the pre-delay time, you may hear click sound, but there is no need to worry about it.

• **REVERB TIME**

This is the length of the later reverberation. In other words, it is the time needed for later reverberation to reduce by 60dB. That is, this shows the wall reflection ratio of an actual room (or hall).

Using the Parameter Knob 6, set the Reverb Time.

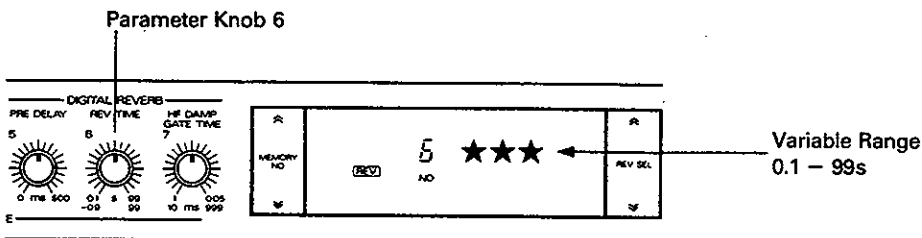
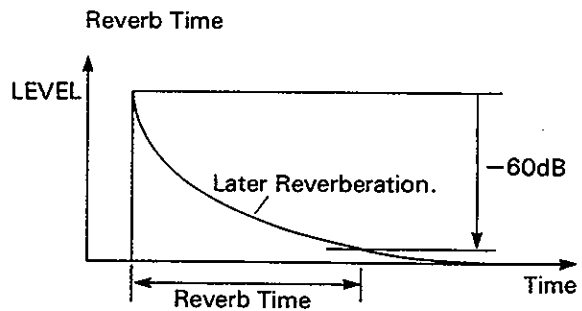

The reverb time is greatly related to the Reverb Selection. Depending on which Reverb is currently selected (Room, Hall, Plate or Special), the highest and lowest limits of the reverb time will vary. (See the table right). This means that changing the Reverbs can automatically fall the reverb time within the range of the limit.

Reverb Selector	Reverb Times(s)	
	Minimum	Maximum
R 76 H 76	0.7	99
R 61 H 61	0.6	99
R 48 H 48	0.5	99
R 36 H 36	0.4	99
R 27 H 27	0.3	72
R 20 H 20	0.2	40
R 14 H 14	0.1	20
R 8.2	0.1	7.5
R 3.1	0.1	3.5
R 1.4	0.1	1.5
R 0.3	0.1	0.5
P 2 P 1	0.7	99
S 2 S 1	1.0	99

• HF DAMP

The HF Damp is the ratio of the higher frequency's reducing. This, in actual room (or hall) means the material which the wall is made of.

* Reverb Time × HF Damp value = Reverb Time of 8kHz.

e.g.)

When the reverb time is 6× and HF Damp value is 0.50, the reverb time of the 8kHz is:

$$6(s) \times 0.50 = 3(s)$$

Set the value of the HF Damp using the Parameter Knob 7.

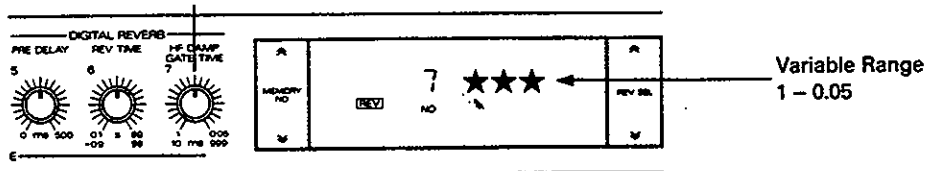
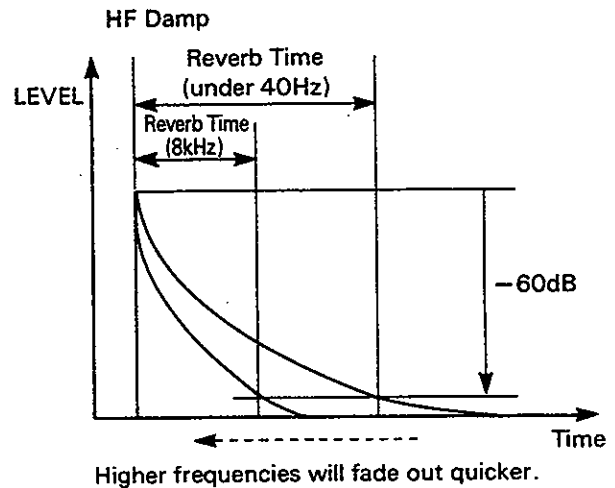

3) Non-linear

Non-linear Reverb (= gate reverb) is the reverb which is cut at a certain gate time, therefore ideal for percussive sound such as snare drum.

* Non-linear Reverb has no early reflections. (See page 7.)

- **PRE-DELAY**

This is the time elapsed between the direct sound and reverberation (ms).

By using the Parameter Knob 5, set the Pre-delay Time.

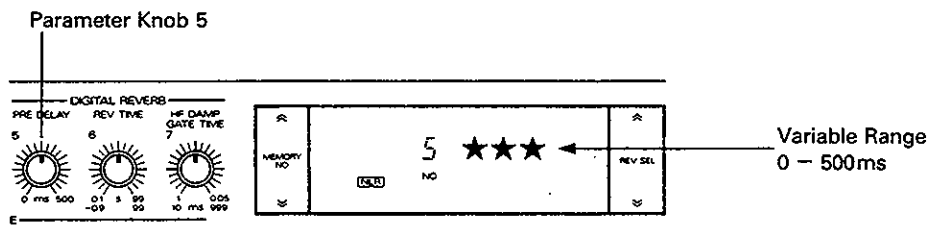

* When changing the pre-delay time, you may hear click noise, but there is nothing to worry about.

● REVERB TIME

This is the time spent for reverberation to complete (ms).

* The Reverb Time can be set to a negative number (-). In this case, the reverberation becomes longer.

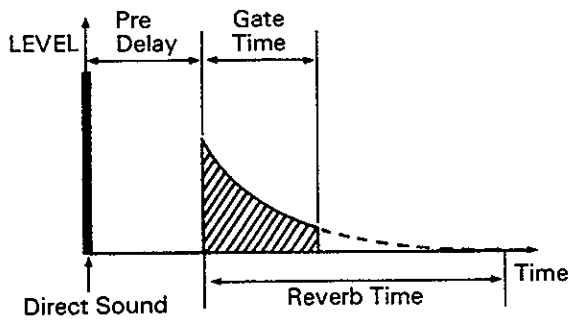

When the reverb time is positive (+).

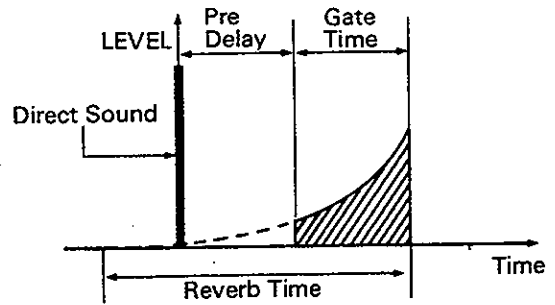

When the reverb time is negative (-).

Set the Reverb Time with the Parameter Knob 6.

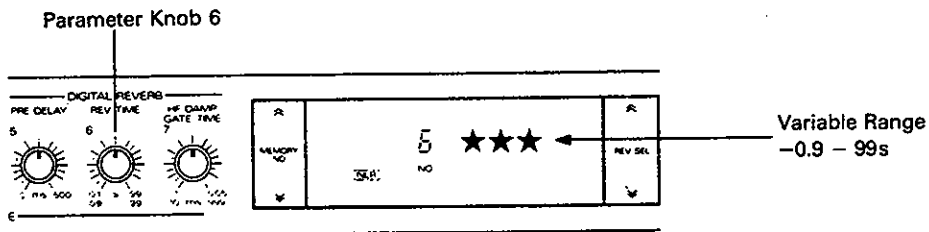

• **GATE TIME**

After the pre-delay time is elapsed, the Gate Time you set here will determine the time needed for the reverberation to end. (ms)

Set the Gate Time with the Parameter Knob 7.

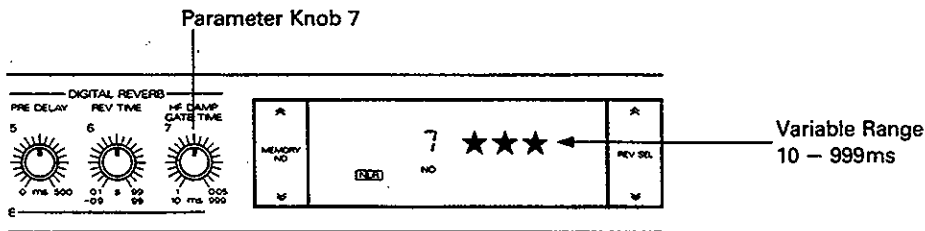

* You may hear a click noise when changing the gate time, but there is nothing to worry about.

Non-linear Output

There are three different ways of sending the Non-linear Reverb as shown below.

1. Usual way of output
2. Panning from Output B to A
3. Panning from Output A to B

Select any of the above three modes by pushing the Reverb Selector Button ⑥.

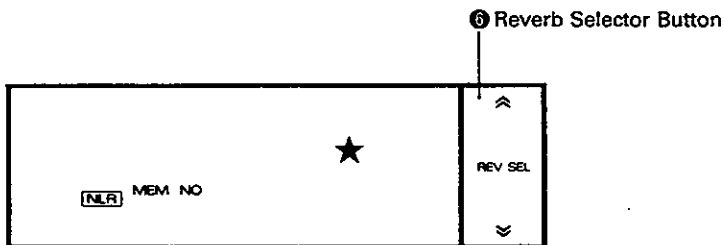

* Pushing the upper side of the button will change the modes as 1 → 2 → 3 and pushing the lower side will change as 3 → 2 → 1.

4) Delay

For setting the parameters of Delay, use the Parameter Knobs 5, 6 and 7.

Set the Delay Time with the Parameter Knob 5.

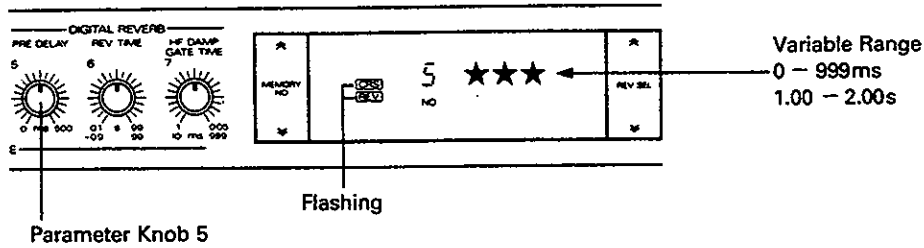

Set the number of the Delay sounds to be repeated with the Parameter Knob 6.

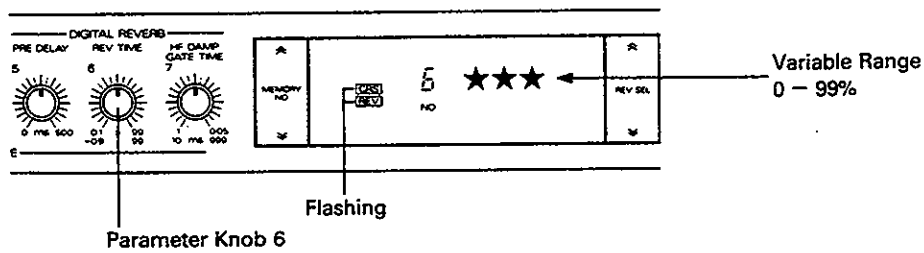

Set the ratio of the higher frequency's reducing with the Parameter Knob 7.

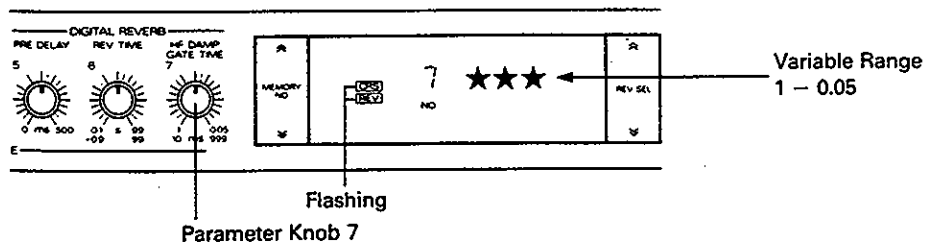

Delay Output

There are three different ways of sending the Delay as shown below.

1. Usual way of output
2. Inverting the phase of the delay
3. Panning Delay (alternately sending the delay from Output A and B)

Select any of the above three modes using the Reverb Selector Button ⑥.

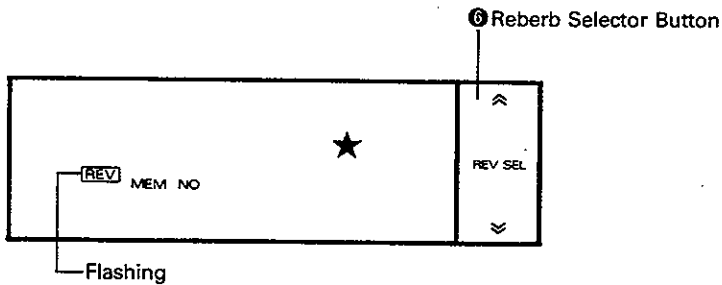

* Pushing the upper side of the button will change the modes as 1 → 2 → 3 and pushing the lower side will change as 3 → 2 → 1.

* In the mode of 3 (Panning Delay), the delay time between Output A and B is the half of the set value.

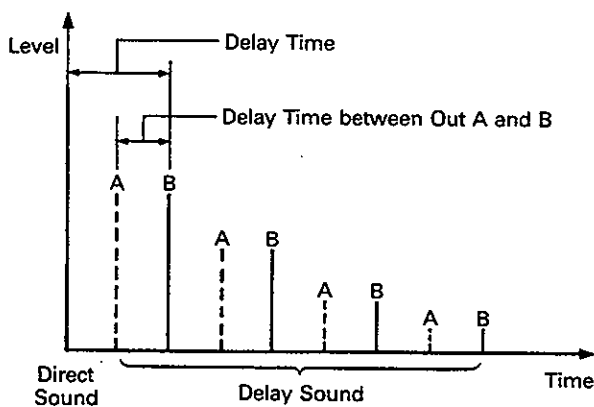

5) Equalizer

The DEP-5 features three band Digital Equalizer where the signal is filtered before going to the Digital Reverb Processor section. The Equalizer changes the frequency characteristics of the effect sounds.

* The Equalizer section has no effect on the direct sounds.

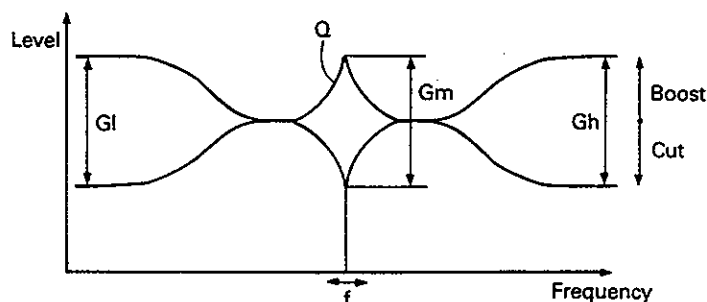

- f: Center Frequency
- Q: Curve that determines the width of the frequency band
- G1, Gm, Gh: Value of Boost/Cut

PROCEDURE

- ① Push the Chorus/EQ Selector Button ⑩ to turn the DEP-5 to the Equalizer mode.

* Make sure that "EQ" appears at the left of the Display.

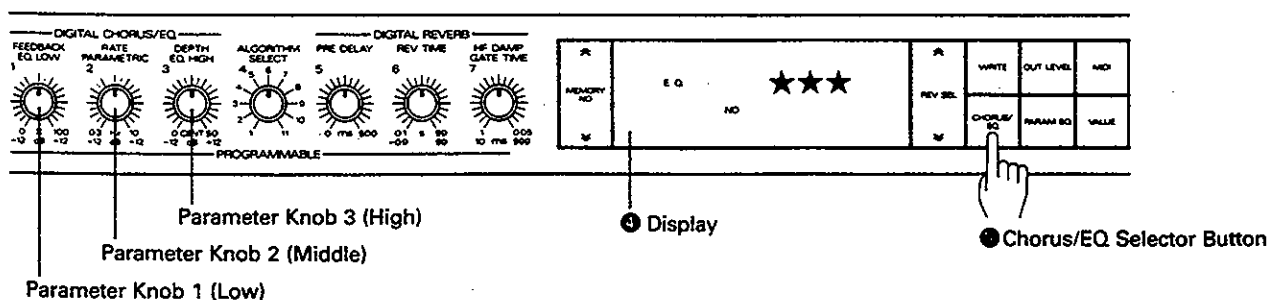

- ② Select the amount (dB) of the boosting or cutting of the Low Filter with the Parameter Knob 1, that of the Middle Filter (Parametric) with the Parameter Knob 2 and that of the High Filter with the Parameter Knob 3.

* The variable range is -12 to $+12$ dB. A positive number boosts and a negative number cuts the frequency.

• HIGH

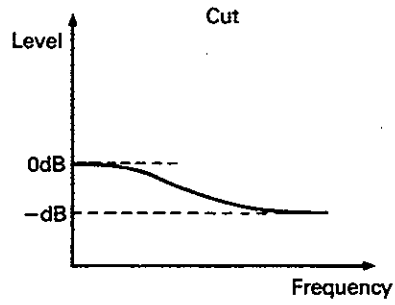
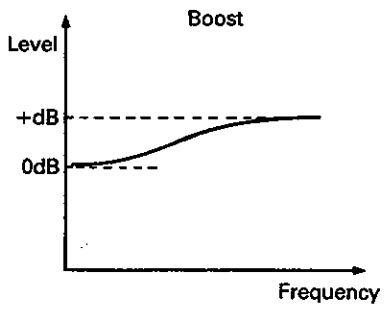

• MID

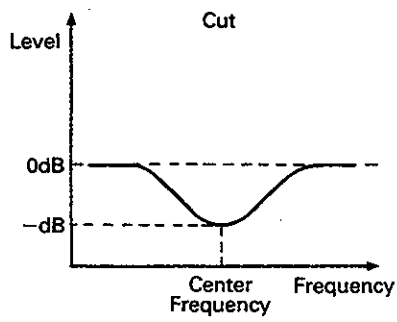
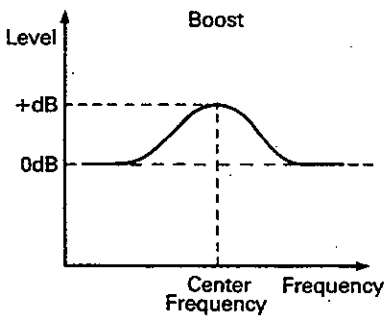

• LOW

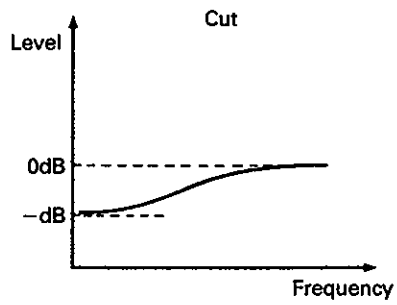
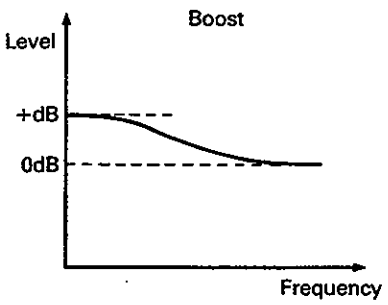

Only the Middle Filter uses a parametric equalizer which allows to set Q (the curve that determines the width of the frequency band) and FRQ (center frequency).

- ③ Push the Parametric EQ Button ① to set Q and FRQ.

The Display shows the current Q value at the left and the FRQ value at the right.

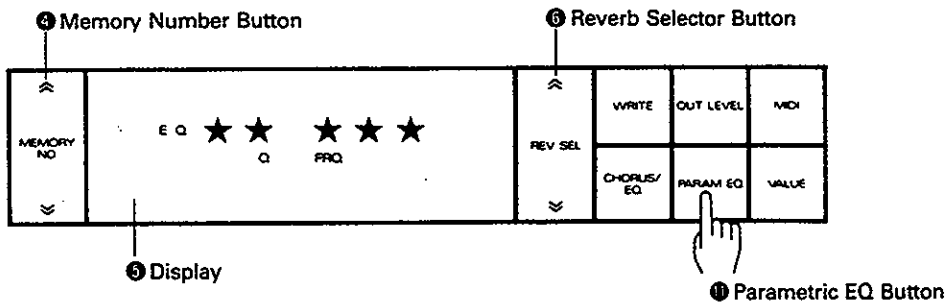

- ④ Change the Q value with the Memory Number Button ④ and the FRQ value with the Reverb Selector Button ⑥.

* The variable range of the Q value is 0.2 to 9.0 and that of the FRQ is 0.30 to 12.0 kHz; both in 128 steps.

* The higher the value of the Q is, the narrower the frequency band of the boost/cut becomes, making a sharper slope of the curve, and vice versa.

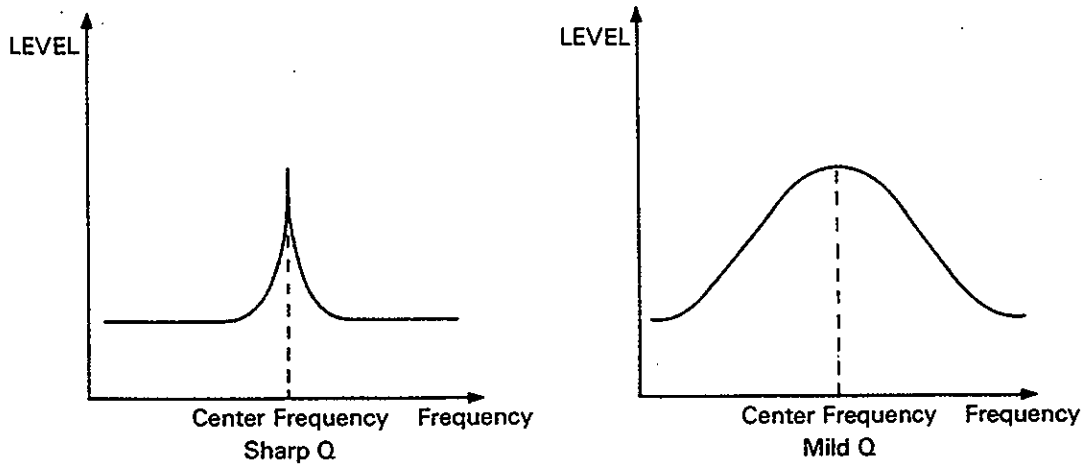

- ⑤ Push the Parametric EQ Button ① to return to the normal mode.

6) Output Level/Balance

When you have finished all effect setting, adjust the Output Level and the balance of the direct and effect sounds as follows.

• Adjusting the Output Level

① Push the Output Level Button ⑧.

The Display shows the current output level at the right.

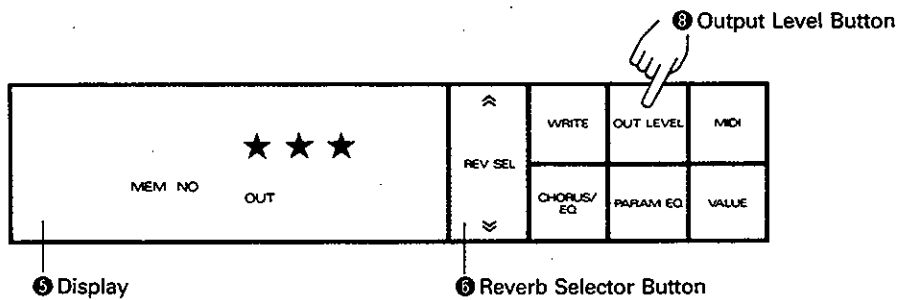

② Using the Reverb Selector Button ⑥, change the output level.

* The variable range is 0 to 99.

③ Push the Output Level Button ⑧ to return to the normal mode.

• BALANCE

By rotating the Balance Knob ③, adjust the balance of the effect and the direct sounds.

* Rotating the knob clockwise will increase the effect sound and counterclockwise rotation will increase the direct sound.

* Please note that the Balance settings cannot be written into memory.

■ Verifying the Parameter Values

You can easily verify the value of each parameter you have set or of the Memory number you have called.

PROCEDURE

- ① Push the Value Button ⑫.

Pushing the button will cause the Display to show the number (1 to 7) of the Parameter Knob you have previously touched and its value.

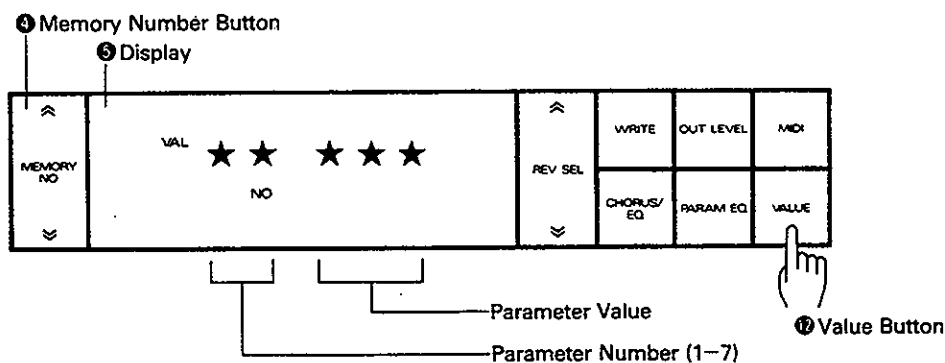

- ② Select the number of the Parameter Knob whose value you wish to verify.

* The Parameter Knobs 1 to 3 work differently depending on which the Chorus or Equalizer mode is currently selected. Change the modes if necessary by pushing the Chorus/EQ Button ⑩.

If you select the parameter which is irrelevant with the Algorithm currently in use, the Display will respond with as shown below.

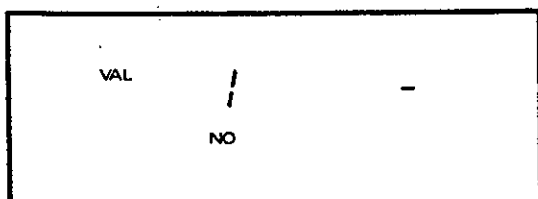

* Even while verifying a parameter, you can change the value of it. Simply move the relevant Parameter Knob, and the Display will show the number of the Parameter Knob and the new value.

- ③ When verification is finished, push the Value Button ⑫ to return to the normal mode.

3. Writing into Memory

The Memory function of the DEP-5 allows you to write the Algorithm and each Parameter setting you have made into memory.

- * If you try to call other Memory number without writing the effect you have made, the right and left of the Display will flash alternately warning you that the effect will be erased. If you wish to retain the data, take the following procedure, and if not, just push the Memory Number Button ④ again.

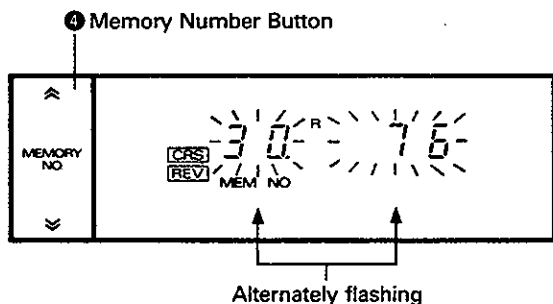

- * Writing a new effect setting will automatically erase the data previously written in that Memory number. The preprogrammed effects from the Memory number 1 to 29, however, can be restored by the following operation.

Turn the unit off, then turn it on while holding the both sides "≈" and "≈" of the Memory Number Button ④ at a time. The Display shows "LD" for about a second and all the memory numbers from 1 to 29 are recalled.

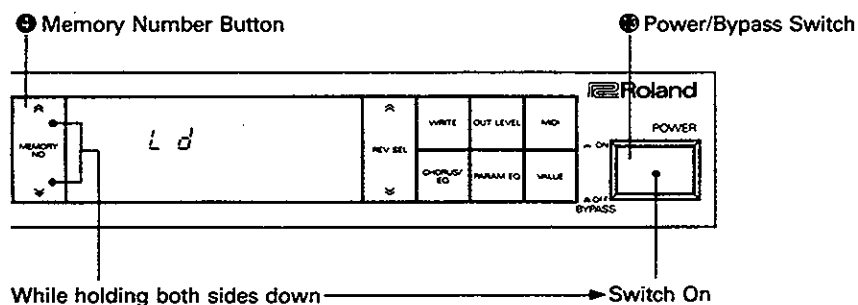

You may write the edited effect setting either to the previous location (same Memory number) or to a different Memory number.

■ Writing into the same Memory number

While holding the Write Button ⑦ down, push the either side of the Memory Number Button ④.

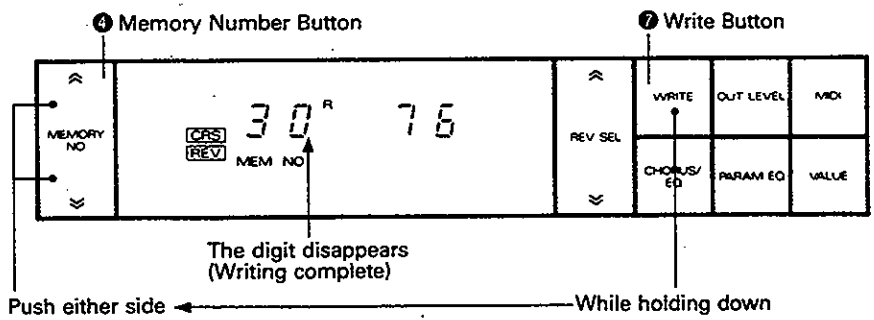

The Display will flash for a moment, then the digit at the lower right of the Memory number will go out showing that the writing is completed.

* The digit at the lower right of the Display always appears during editing or programming data and goes out when the data is written into memory.

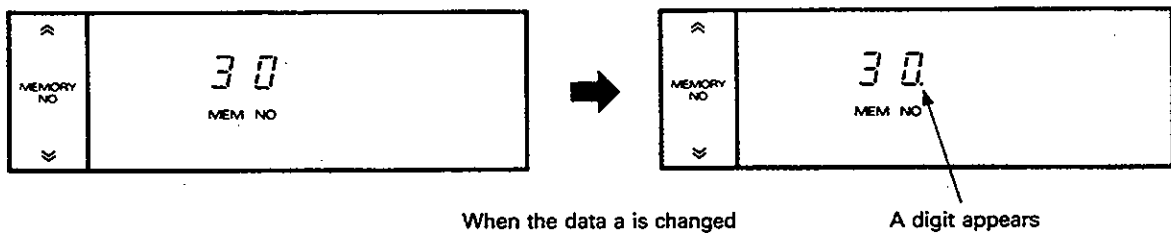

■ Writing into a different Memory number

- ① Push the Write Button ⑦.

The number shown in the Display will flash.

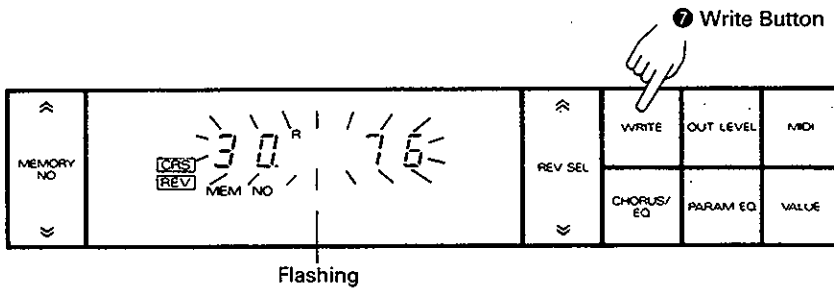

* Pressing the Write Button again will stop the flashing and leave the Writing mode.

- ② Using the Memory Number Button ④, select the Memory number where you wish the edited effect setting to be written.

The number in the Display stops flashing.

- ③ While holding the Write Button ⑦ down, press either side of the Memory Number Button ④.

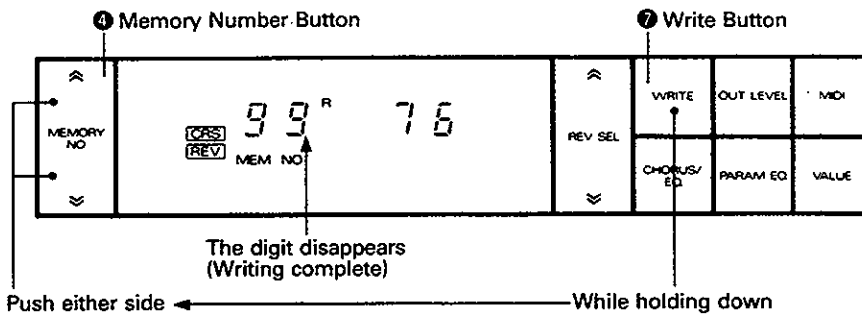
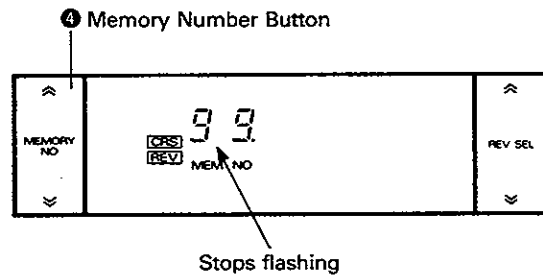

The digit at the lower right of the Memory number will go out showing that the writing is completed.

4. Remote Control

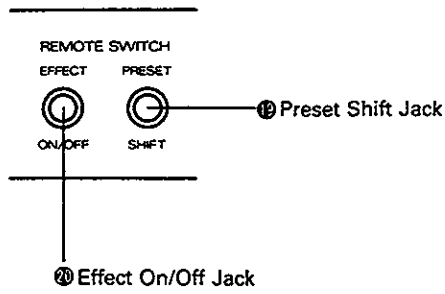

■ PRESET SHIFT (Calling a Memory number)

Connect the Pedal Switch DP-2 to the Preset Shift Jack 19, and the effect settings of Memory numbers 1 to 8 can be sequentially called as → 1 → 2 → 3 → 4 → 5 → 6 → 7 → 8 → just by pressing the pedal.

* When the effect setting other than Memory number 1 to 8 (9 to 99) is currently in use, pressing the pedal will automatically call Memory number 1.

* When you are calling effect settings by using the Preset Shift function, the effect sound may be muted for a moment, but there is no need to worry about it.

■ EFFECT ON/OFF

Connect the Foot Switch FS-1 or the Pedal Switch DP-2 to the Effect On/Off Jack 20, and the effect can be turned on or off by using the pedal.

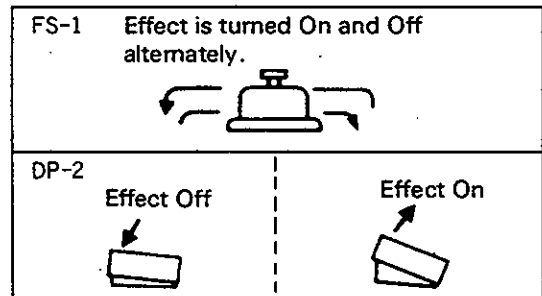

5 SELECTING EFFECT SETTINGS WITH MIDI

You can call an effect setting on the DEP-5 by operating the external device.

For instance, by changing the patches on the synthesizer connected to the DEP-5, the corresponding effect setting on the DEP-5 can be recalled. For this, however, it is necessary to properly set the MIDI Channel number and OMNI ON/OFF, then make combination of the Program Change numbers on the external device and the Memory numbers on the DEP-5. (Refer to the separate booklet "MIDI".)

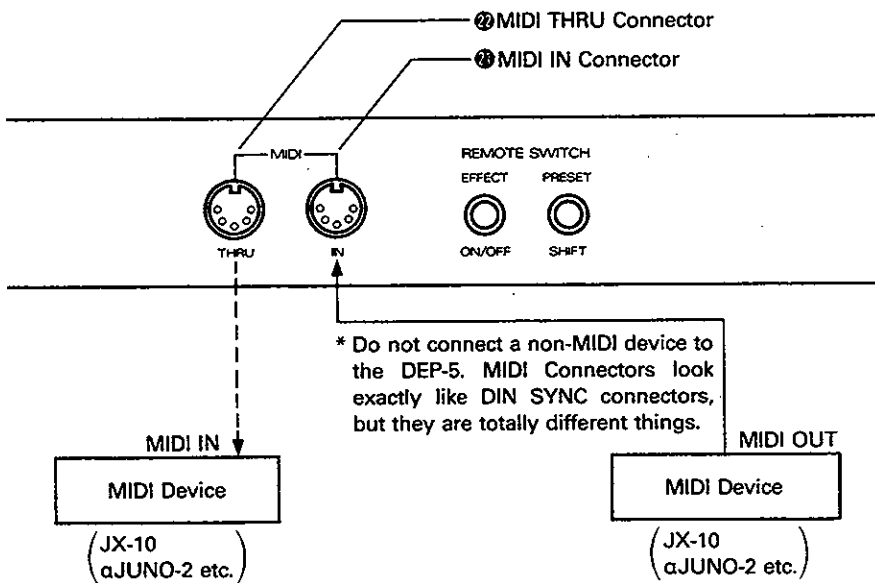

* If you do not need to change the current setting of the OMNI ON/OFF or MIDI Channel, skip the following "1) Setting OMNI ON/OFF and MIDI Channel" and go directly to "2) Making the combinations of Memory numbers and Program Change numbers".

1) Setting OMNI ON/OFF and MIDI Channel

- 1 Push the MIDI Button ⑨.

The right side of the Display shows the current MIDI Channel number and the left side shows OMNI ON/OFF setting.

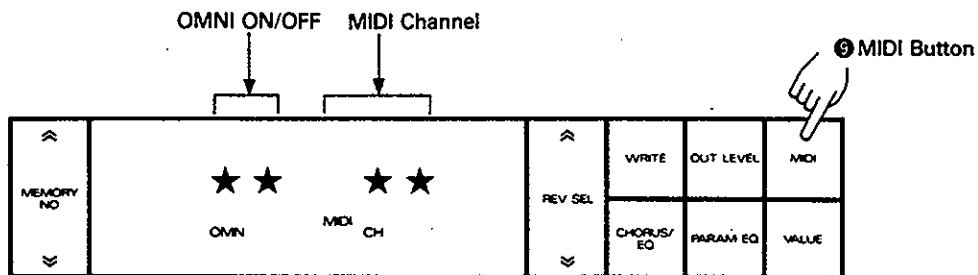

- 2 Using the Memory Number Button ④, set OMNI ON or OFF.

* Pushing the upper side will select the OMNI ON, and the lower side OFF.

- 3 If you have selected OMNI OFF in the step ②, set an appropriate MIDI channel number (1 to 16) using the Reverb Selector Button ⑥.

- 4 Push the MIDI Button ⑨.

The left side of the Display shows the Memory number and the right side shows the Program Change number that corresponds to the Memory number.

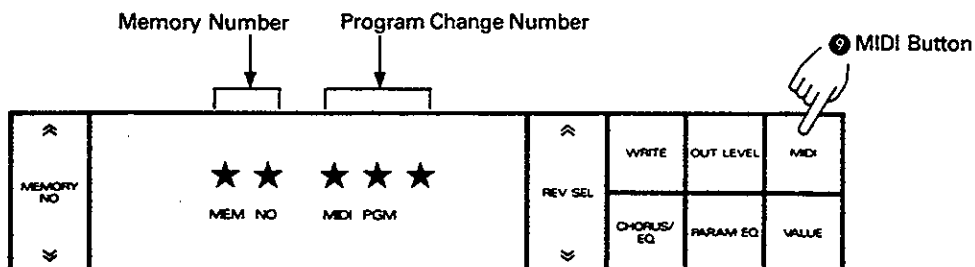

* If you do not want to change the combination, push the MIDI Button to return to the normal mode. To change the combination, go to the next procedure.

2) Making the combinations of Memory numbers and Program change numbers

① Using the Reverb Selector Button ⑥, change to the Program Change number you like (1 to 128).

* The Memory number that corresponds to the Program Change number currently selected will be shown at the left of the Display.

② Recall the Memory number using the Memory Number Button ④ (1 to 99).

* If you have been editing an effect of a certain Memory number and try to call a different Memory number without writing it into memory, the Display will react as shown on page 34.

To make other combinations, repeat the steps ① and ②.

③ Push the MIDI Button ⑨ to return to the normal mode.

* When returned to the normal mode, the previous Memory number and the effect setting will be recalled.

Frequency Characteristic

[Direct]

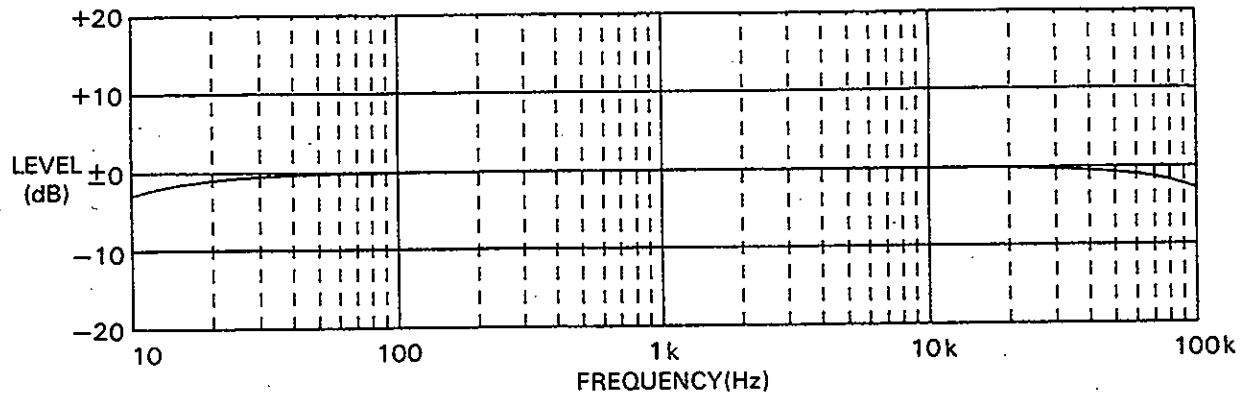

[Effect]

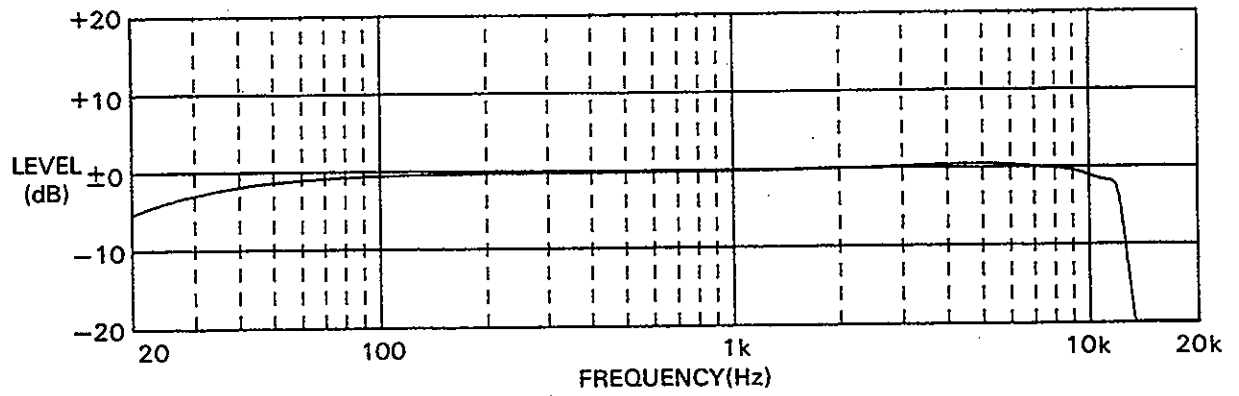

Parametric Equalizer Characteristic

[EQ High]

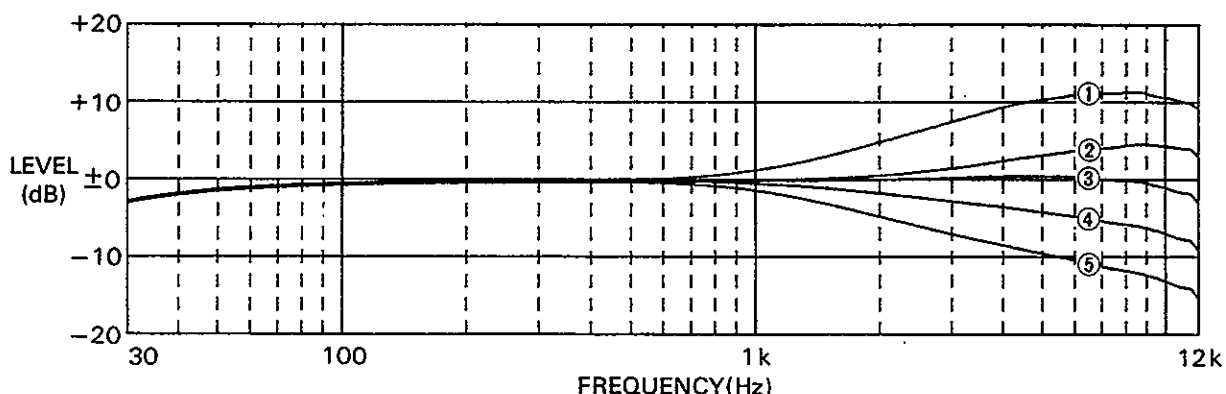

BOOST/CUT	①+12dB	②+6dB	③±0dB	④-6dB	⑤-12dB
-----------	--------	-------	-------	-------	--------

[EQ Mid]

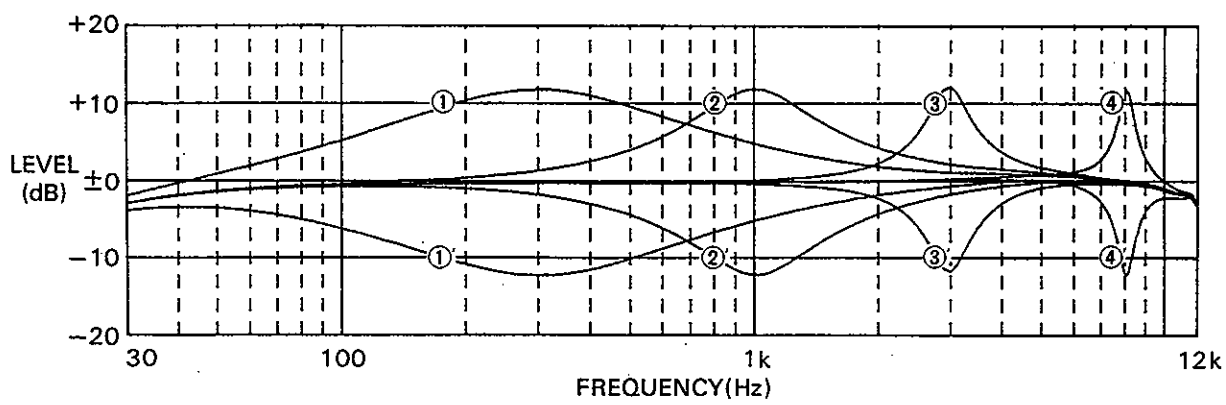

BOOST/CUT	CENTER FREQUENCY	Q	BOOST/CUT	CENTER FREQUENCY	Q	BOOST/CUT	CENTER FREQUENCY	Q	BOOST/CUT	CENTER FREQUENCY	Q
① +12dB	0.3kHz	0.6	② +12dB	1.01kHz	1.4	③ +12dB	3.06kHz	4.0	④ +12dB	7.99kHz	9.0
① -12dB			② -12dB			③ -12dB			④ -12dB		

[EQ Low]

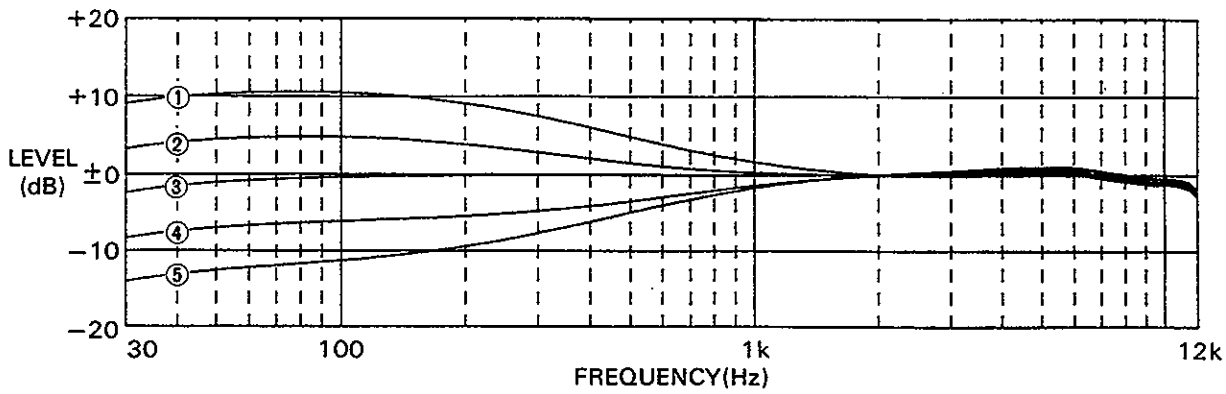

BOOST/CUT	①+12dB	②+6dB	③±0dB	④-6dB	⑤-12dB
-----------	--------	-------	-------	-------	--------

Block Diagram

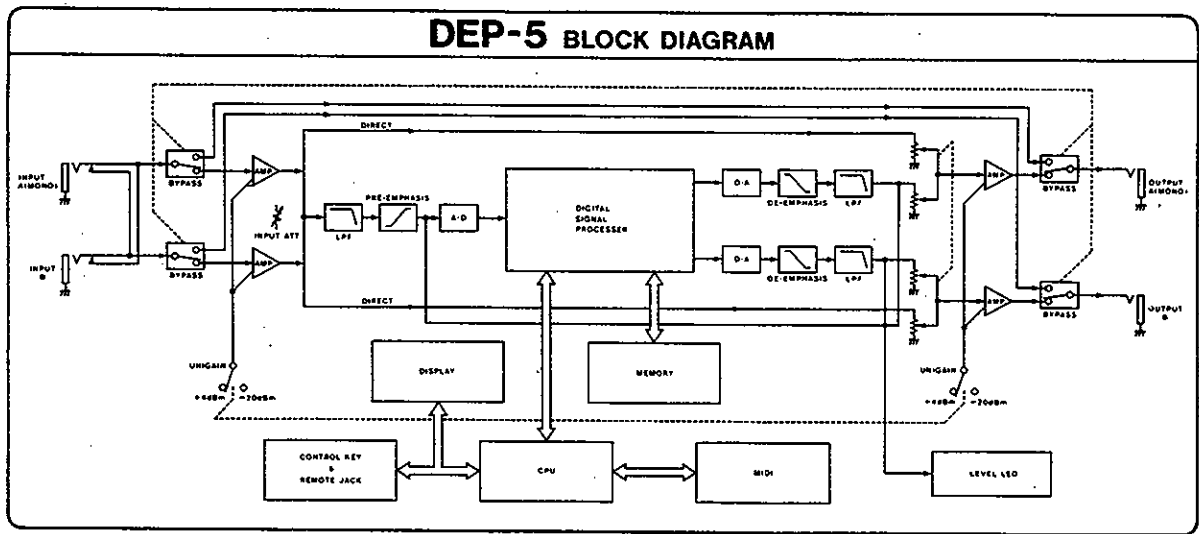

Fixing to the 19" Rack.

Use 5mm screws.

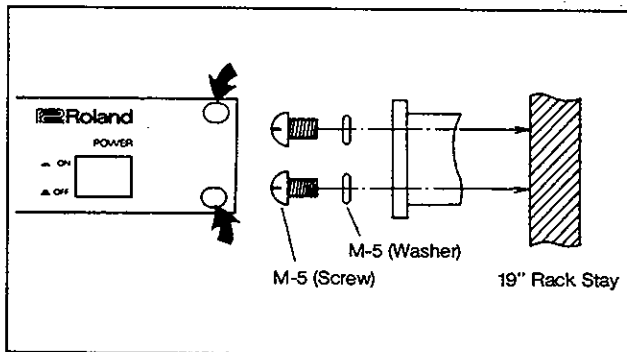

Options



Foot Switch FS-1



Pedal Switch DP-2

6 MEMO

Effect Setting Memo

MEMORY No.	REMARK	CHORUS			E Q			ALGORITHM SELECT	Pre Delay [ms]	Reverb Time [S]	HF Damp Gate Time [ms]	Reverb Select	PARAMETRIC EQUALIZER		Out Level
		Feedback [%]	Rate [Hz]	Depth [CENT]	Low [dB]	Mid (Parametric) [dB]	Hi [dB]		Delay Time [ms.s]	Feedback [%]	HF Damp	Output	Q	Frequency [kHz]	

MEMORY No.	REMARK	CHORUS			E Q			ALGORITHM SELECT	Pre Delay [ms]	Reverb Time [S]	HF Damp Gate Time [ms]	Reverb Select	PARAMETRIC EQUALIZER		Out Level
		Feedback [%]	Rate [Hz]	Depth [CENT]	Low [dB]	Mid (Parametric) [dB]	Hi [dB]		Delay Time (ms,s)	Feedback [%]	HF Damp	Output	Q	Frequency [kHz]	

MEMORY No.	REMARK	CHORUS			E Q			ALGORITHM SELECT	Pre Delay (ms)	Reverb Time (S)	HF Damp Gate Time (ms)	Reverb Select	PARAMETRIC EQUALIZER		Out Level
		Feedback [%]	Rate [Hz]	Depth [CENT]	Low [dB]	Mid (Parametric) [dB]	Hi [dB]		Delay Time (ms,s)	Feedback [%]	HF Damp	Output	Q	Frequency [kHz]	

MEMORY No.	REMARK	CHORUS			E Q			ALGORITHM SELECT	Pre Delay (ms)	Reverb Time (S)	HF Damp Gate Time (ms)	Reverb Select	PARAMETRIC EQUALIZER		Out Level
		Feedback (%)	Rate (Hz)	Depth (CENT)	Low (dB)	Mid (Parametric) (dB)	Hi (dB)		Delay Time (ms.s)	Feedback (%)	HF Damp	Output	Q	Frequency (kHz)	

7 SPECIFICATIONS

Input Level/Impedance

+4dBm (+18dBm Max.)/56k Ω
-20dBm (-5dBm Max.)/Over 100k Ω

Output Level/Impedance

+4dBm (+18dBm Max.)/100 Ω
-20dBm (-5dBm Max.)/650 Ω

AD-DA System

16 bit Linear

Sampling Frequency

32 kHz

Frequency Response

10kHz to 100kHz \pm $\frac{0}{3}$ dB (Direct)
30Hz to 12kHz \pm $\frac{0}{3}$ dB (Effect)

SN Ratio (IHF A at Rated Input)

95dB (Direct)
80dB (Effect)

Dynamic Range

Over 105dB (Direct)
Over 90dB (Effect)

Total Harmonic Distortion (1kHz at Rated Input)

Below 0.008% (Direct)
Below 0.03% (Effect)

Pre-delay Time

0 to 500ms at Reverb Mode
0 to 500ms at Non-linear Mode

Reverb Time

0.1s to 99s at Reverb Mode
-0.9s to 99s at Non-linear Mode

HF Damp Control

\times 0.05 to \times 1.0

Gate Time

10 to 999ms

Reverb Selection

ROOM: 0.3 to 76 (11 Levels)
HALL: 14 to 76 (7 Levels)
PLATE: 1 and 2
SPECIAL: 1 and 2

Equalizer

LOW: Frequency: 100Hz
Boost/Cut: +12dB to -12dB

HIGH: Frequency: 10kHz
Boost/Cut: +12dB to -12dB

PARAMETRIC: Frequency: 300Hz to 12kHz
Boost/Cut: +12dB to -12dB
Q: 0.2 to 9.0

Chorus

Feedback: 0 to 100%
Rate: 0.3 to 10Hz
Depth: 0 to 50 cent

Delay Time

0 to 2000ms

Consumption

29W

Dimensions

482(W) \times 47(H) \times 289(D) mm
19"(W) \times 1 $\frac{7}{8}$ "(H) \times 11 $\frac{3}{8}$ "(D) mm

Weight

5.0kg/11 lb.

Accessories

Connection Cord \times 2

Example Settings

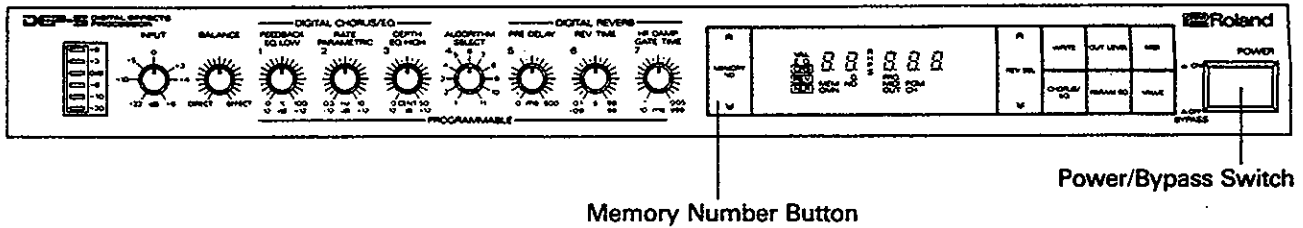

■ The tables on page 2 show the factory preprogrammed effects 1 to 99.

By turning the DEP-5 on while holding the both sides of MEMORY NO Button down, you can recall the factory preprogrammed effects 1 to 29. This erases the data Currently written in the Memory Number 1 to 29.

The preprogrammed effects 30 to 99 cannot be recalled once you have rewritten.

■ The pictures below show the combinations of the Equalizer, Reverb, Delay, Non-linear and Chorus which are set with the Algorithm Select and the flowchart of the signals.

1. EQ, CHORUS

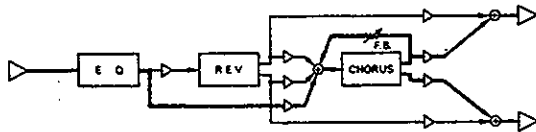

2. EQ, REVERB

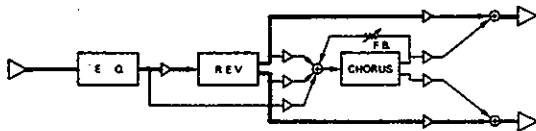

3. EQ, REVERB (MOD)

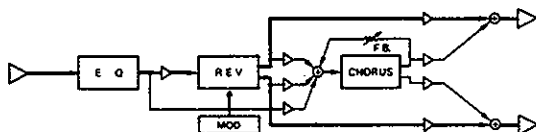

4. EQ, REVERB, CHORUS (Series)

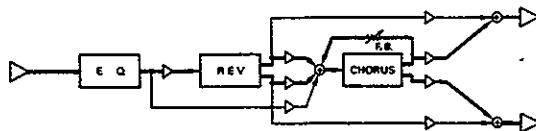

5. EQ, REVERB, CHORUS (Parallel)

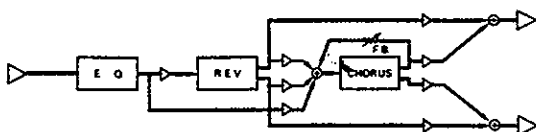

6. EQ, REVERB, CHORUS (Parallel)

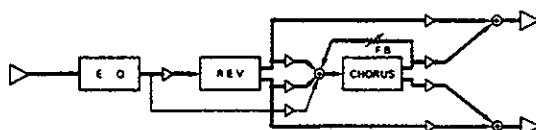

7. EQ, NON LNR

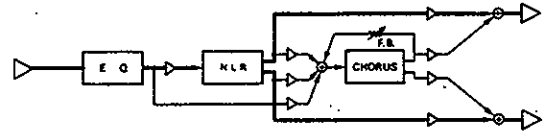

8. EQ, NON LNR (MOD)

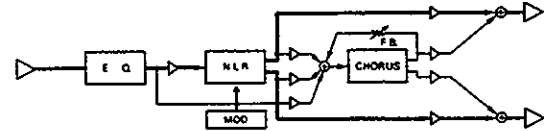

9. EQ, NON LNR, CHORUS (Parallel)

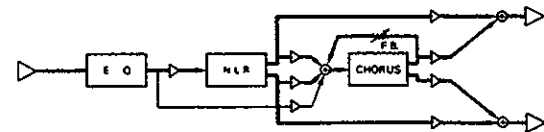

10. EQ, DELAY, CHORUS (Parallel)

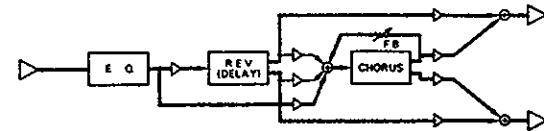

11. EQ, NON LNR (MOD)

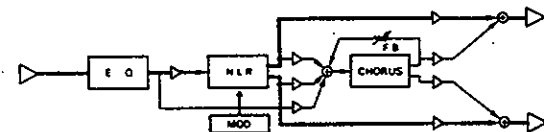

MEMORY No.	REMARK	CHORUS			E Q			ALGORITHM SELECT	Pre Delay [ms]	Reverb Time [S]	HF Damp Gate Time [ms]	Reverb Select	PARAMETRIC EQUALIZER		Out Level	
		Feedback [%]	Rate [Hz]	Depth [CENT]	Low [dB]	Mid (Parametric) [dB]	Hi [dB]		Delay Time [ms.s]	Feedback [%]	HF Damp	Output	Q	Frequency [kHz]		
Reverb	1	Natural Reverb	—	—	—	1	-5	-5	2	10	3.1	0.26	R 14	0.6	1.60	30
	2	Concert Hall	—	—	—	1	-1	0	2	36	2.5	0.71	H 36	0.4	0.59	25
	3	Cathedral	—	—	—	-1	-1	-2	2	42	3.1	0.64	R 48	0.4	1.27	40
	4	Bright Room	—	—	—	-4	-3	-1	2	10	1.1	1.00	R 20	1.0	2.03	30
	5	Space	—	—	—	0	2	5	2	0	29	0.05	P 2	0.6	5.31	40
	6	Plate	—	—	—	0	1	2	2	38	3.0	0.71	P 1	0.9	6.15	36
	7	Total Balance	—	—	—	2	-1	0	2	3	3.5	0.30	R 14	0.2	0.37	30
Non Linear	8	Hard Gate	—	—	—	-1	2	0	7	0	3.8	171	1	0.2	1.75	45
	9	Reverse Gate	—	—	—	1	3	3	7	0	-0.9	234	1	0.2	1.75	45
	10	Pan Ricochet	—	—	—	1	2	0	7	54	99	115	2	0.2	1.75	45
	11	Panning Bounce	—	10.0	8.7	10	10	-3	11	21	88	455	3	3.2	1.80	40
Chorus & Delay	12	Chorus	0.0	1.1	8.5	-2	4	3	1	—	—	—	1	0.2	0.30	60
	13	Flange	90.7	1.1	0.9	-2	-2	3	1	—	—	—	1	0.2	0.30	60
	14	Pan Slaps	0	1.1	0	0	0	0	10	122	15.3	1.00	3	0.2	0.30	60

MEMORY No.	REMARK	CHORUS			E Q			ALGORITHM SELECT	Pre Delay [ms]	Reverb Time [S]	HF Damp Gate Time [ms]	Reverb Select	PARAMETRIC EQUALIZER		Out Level	
		Feedback [%]	Rate [Hz]	Depth [CENT]	Low [dB]	Mid [Parametric] [dB]	Hi [dB]		Delay Time [ms,s]	Feedback [%]	HF Damp	Output	Q	Frequency [kHz]		
Chorus Reverb & Chorus NLR	15	Chorus Reverb 1	—	1.3	3.5	3	1	-3	3	0	2.6	0.45	H 48	0.6	6.15	45
	16	Chorus Reverb 2	69.5	10.0	0.3	7	-1	8	5	130	9.9	0.49	P 1	2.0	0.53	40
	17	Flanged Non Linear	96.6	5.5	6.0	-10	-3	3	9	0	-0.9	10	3	2.5	7.99	40
	18	Bi Phaser	79.5	0.3	4.8	0	12	-8	9	255	-0.9	999	1	8.0	12.0	60
Special Effects	19	Spinners	79.7	0.3	50.0	-2	4	3	4	0	40	0.50	R 20	0.2	0.30	60
	20	Flanged Infinite	66.0	0.3	0.5	0	0	2	4	39	53	0.60	H 76	0.2	0.30	60
	21	Rise & Fall	89.9	0.3	50.0	0	-2	-2	9	0	-0.9	25	2	1.3	2.35	60
	22	Sublimation	—	8.9	0.3	6	-2	5	3	0	20	0.36	S 1	4.4	0.79	60
For Instruments	23	Sax	59.7	0.3	1.5	5	2	-3	5	2	2.6	0.55	H 14	3.0	0.30	30
	24	Snare	—	—	—	3	4	0	2	425	1.2	0.60	R 20	0.3	5.01	25
	25	Piano	—	—	—	2	-2	-2	2	3	3.5	0.32	R 14	1.5	2.03	30
	26	Guitar	0	8.9	0.3	6	-2	4	4	11	1.6	0.18	H 14	4.5	0.83	35
	27	Muted Guitar	—	10.0	0.3	7	1	3	3	11	0.5	0.55	R 3.1	2.0	3.15	30
	28	Bass	66.6	3.4	0.6	5	2	-3	5	2	0.7	0.55	H 14	3.0	0.30	30
	29	Voice	—	—	—	0	-4	6	2	209	0.7	1.00	R 76	0.2	0.30	50

MEMORY No.	REMARK	CHORUS			E Q			ALGORITHM SELECT	Pre Delay [ms]	Reverb Time [S]	HF Damp Gate Time [ms]	Reverb Select	PARAMETRIC EQUALIZER		Out Level
		Feedback [%]	Rate [Hz]	Depth [CENT]	Low [dB]	Mid (Parametric) [dB]	Hi [dB]		Delay Time [ms.s]	Feedback [%]	HF Damp	Output	Q	Frequency [kHz]	
30	Concert Hall #1	--	--	--	0	1	5	2	38	3.2	0.71	H20	0.7	6.15	60
31	Concert Hall #2	--	--	--	0	1	5	2	11	3.2	0.71	H36	0.7	6.15	60
32	Long Hall	--	--	--	0	1	5	2	39	5.3	0.55	H76	0.7	6.15	60
33	Almost Infinite	--	--	--	0	1	5	2	39	21	0.21	H76	0.7	6.15	60
34	Auditorium	--	--	--	0	1	5	2	57	1.4	0.71	H14	0.7	6.15	60
35	Plate #2	--	--	--	-3	-1	3	2	65	2.9	0.73	P2	0.2	0.30	60
36	Predelay Long Hall	--	0.3	5.1	-2	-3	-1	3	278	3.7	0.73	H20	0.2	1.04	60
37	Small Panning Room	--	--	--	0	1	3	7	0	0.8	365	3	0.2	0.30	60
38	Small #1 Bright Room	--	--	--	6	1	3	7	0	0.3	489	1	0.2	0.30	60
39	Large #1 Bright Room	--	--	--	-2	-2	-1	2	0	1.1	1.00	R36	1.0	2.03	60
40	Tiled Room	--	--	--	-2	-2	-1	2	0	0.4	1.00	R20	1.0	2.03	60
41	Bright Dome	--	--	--	-4	-3	-1	2	0	1.1	1.00	H27	1.0	2.03	60
42	Kitchen #1	--	--	--	-4	-3	-1	2	0	0.5	0.71	H14	1.0	2.03	60
43	Kitchen #2	--	--	--	-1	0	0	2	0	0.3	0.71	H27	0.2	0.30	60
44	Pan Gate #1	--	--	--	0	2	0	7	0	99	214	2	0.2	1.75	60
45	Long Gate	--	--	--	-1	2	-2	7	0	99	281	1	0.2	3.15	60
46	Pan Gate #2	--	--	--	-1	2	0	7	54	99	422	2	0.2	1.75	60
47	Dense Gate #1	--	0.3	0	-1	1	-2	11	13	99	140	1	0.2	0.81	60
48	Modulated Gate	--	1.3	50.0	-1	2	2	8	13	99	76	1	0.2	1.75	60
49	Modulated Pan Gate	--	1.3	50.0	-1	2	2	8	13	99	211	3	0.2	1.75	60
50	Non linear Rm	--	--	--	1	3	2	7	13	0.9	441	1	0.2	0.98	60

MEMORY No.	REMARK	CHORUS			EQ			ALGORITHM SELECT	Pre Delay [ms]	Reverb Time [S]	HF Damp Gate Time [ms]	Reverb Select	PARAMETRIC EQUALIZER		Out Level
		Feedback [%]	Rate [Hz]	Depth [CENT]	Low [dB]	Mid (Parametric) [dB]	Hi [dB]		Delay Time [ms.s]	Feedback [%]	HF Damp	Output	Q	Frequency [kHz]	
51	Pan Slaps #1	0	0.3	0	0	0	0	10	114	33.1	1.00	3	0.2	0.30	60
52	Panning Delay #1	0	0.3	0	0	0	0	10	739	6.3	1.00	3	0.2	0.30	60
53	Echo #1	0	0.3	0	0	0	0	10	311	43.4	0.64	2	0.2	0.30	67
54	Stereo Filtered Delay	0	0.3	0	0	0	0	10	216	89.7	0.05	3	0.2	0.30	60
55	EQ'd Slap	0	0.3	0	2	12	3	10	55	0	1.00	2	0.2	1.65	39
56	1 Second Pan Echo	0	0.3	0	0	0	0	10	2	57.4	0.82	2	0.2	0.30	60
57	Chorus 2	0	0.8	6.0	-2	-2	5	1	-	-	-	1	0.2	0.30	60
58	Tremolo Leslie	0	10.0	16.2	-2	11	-1	1	-	-	-	1	0.2	1.16	74
59	Harmonized Honky Tonk	0	0.3	20.0	-11	5	0	1	-	-	-	1	0.2	2.21	84
60	Chorus 3	50.1	5.1	13.0	-2	-1	-1	1	-	-	-	1	1.2	2.03	60
61	Flange #2	68.0	0.3	1.3	-2	-2	3	1	-	-	-	1	0.2	0.30	60
62	Flange + Double	68.0	0.3	1.3	-2	-2	3	10	74	0	0.71	3	0.2	0.30	60
63	Chorus + Double #1	0	2.4	10.2	-2	-2	3	10	57	0	0.71	3	0.2	0.30	60
64	Flange Small Room 1	84.5	0.3	0	1	1	0	4	0	0.4	0.97	H 14	0.2	0.30	60
65	Chorus + Long Hall 1	0	2	10.0	1	1	3	5	19	3.5	0.97	H 14	0.2	0.30	60
66	Chorused Long Hall	0	1.2	15.5	1	1	4	6	21	2.9	0.97	H 36	0.2	0.30	69
67	Tremolo Room	0	10.0	16.2	-2	-12	-2	4	0	1.1	0.71	R 8.2	0.2	1.51	60
68	Flange + Big Room	90.7	1.1	0.9	-4	-3	-3	5	11	3.2	0.71	R 48	1.3	1.91	60
69	Chorus + Long Hall 2	0	1.1	8.5	-2	4	3	5	82	2.7	0.83	H 27	0.2	0.30	60
70	Harmonized Large Room	0	1.1	8.5	-2	4	3	4	48	2.6	0.91	R 76	0.2	0.30	60

MEMORY No.	REMARK	CHORUS			E Q			ALGORITHM SELECT	Pre Delay (ms)	Reverb Time (S)	HF Damp Gate Time (ms)	Reverb Select	PARAMETRIC EQUALIZER		Out Level
		Feedback (%)	Rate (Hz)	Depth (CENT)	Low (dB)	Mid (Parametric) (dB)	Hi (dB)		Delay Time (ms.s)	Feedback (%)	HF Damp	Output	Q	Frequency (kHz)	
71	Chorused Pan Gate	0	1.1	8.5	-2	4	3	9	0	1.1	255	3	0.2	0.30	88
72	Flanged Pan Gate	64.8	0.4	1.8	-2	0	3	9	0	99	296	3	0.2	0.30	68
73	Regeneration Reverse Pan	92.5	0.7	50.0	0	0	0	9	0	-0.9	672	2	0.2	0.30	60
74	Flanged Non Linear Pan	87.2	0.6	1.4	-2	-4	-3	9	0	99	767	2	0.9	1.97	65
75	Chorused Gate	0	1.1	7.9	-1	1	-3	9	0	84	281	1	0.2	0.51	51
76	Chorused #1 Non linear room	0	0.9	7.0	0	1	3	9	0	0.8	365	3	0.2	0.30	60
77	Chorused #2 Non linear room	0	0.3	5.7	1	3	3	9	13	0.9	441	1	0.2	0.98	60
78	Reverse Bounce 1	-	0.3	0	1	-1	-1	11	0	-0.9	999	1	1.5	2.64	60
79	Panning Bounce Gate	-	0.3	0	1	-1	-1	11	0	99	999	2	1.5	2.64	60
80	Reverse Bounce 2	-	0.3	0	1	-1	-1	11	0	-0.9	292	1	1.5	2.64	60
81	Inverse Room 1	-	-	-	6	1	0	7	0	-0.9	999	1	0.2	0.30	60
82	Inverse Room 2	-	-	-	6	1	3	7	0	-0.9	427	1	0.2	0.30	60
83	Panning Inverse Room 1	-	-	-	2	12	3	7	0	-0.9	296	2	0.2	1.19	69
84	Panning Inverse Room 2	-	-	-	-2	1	3	7	190	-0.9	361	2	0.2	0.30	60
85	Chorus & Panning Delay 1	0	0.9	11.7	-2	-2	-2	10	305	33.1	1.00	3	1.2	2.21	9
86	Chorus & Stereo Slaps	0	0.3	8.5	0	-1	-2	10	114	33.1	1.00	3	1.2	2.03	60
87	Vibrato & Echo	0	10.0	12.0	0	0	0	10	32	43.4	0.82	2	0.2	0.30	67
88	Slow Chorus Echo	0	0.4	4.7	0	0	0	10	281	52.8	0.64	2	0.2	0.30	67
89	Thick Chorus & 1 sec Pan Echoes	49.7	0.6	9.5	0	-1	-1	10	2.0	57.4	1.00	3	1.0	2.03	60
90	Flanging & 2 sec Echo	75.7	0.3	1.4	0	-1	-1	10	2.0	57.4	0.82	2	1.0	2.03	60
91	Chorus & 120 BPM Pan Echo	0	0.8	7.7	0	-1	-1	10	491	39.6	1.00	3	1.0	2.03	60

Special Rooms and Effects

MEMORY No.	REMARK	CHORUS			E Q			ALGORITHM SELECT	Pre Delay [ms]	Reverb Time [S]	HF Damp	Reverb Select	PARAMETRIC EQUALIZER		Out Level
		Feedback [%]	Rate [Hz]	Depth [CENT]	Low [dB]	Mid (Parametric) [dB]	Hi [dB]		Delay Time [ms,s]	Feedback [%]	HF Damp		Output	Q	
92	Metallic Tank =1	0	1.1	0	0	0	0	10	10	24.3	1.00	3	0.2	0.30	60
93	Metallic Tank =2	91.0	0.3	1.1	0	0	0	10	15	84.0	1.00	3	0.2	0.30	60
94	Special Room =2	—	—	—	0	-4	-4	2	0	2.0	1.00	S 2	0.4	1.55	60
95	Special =1	—	—	—	0	-3	4	2	0	10	0.93	S 1	0.4	0.98	60
96	Phased Long room	—	—	—	0	-3	4	2	75	11	0.46	S 1	0.4	0.98	60
97	Delay Flanged & Phased long room	0	2.9	16.0	-3	-4	2	6	86	11	0.46	S 1	0.5	0.83	60
98	Modulated Phased room	—	10.0	14.7	-3	-4	3	3	10	1.0	1.00	S 1	0.5	0.83	60
99	Test Parametar	0	0.3	0	0	0	0	10	0	0	1.00	1	0.2	0.30	60

(Front Panel)

Input Attenuator

Balance Volume

Controls

Feedback Level/Equalizer Boost (Cut)
Modulation Rate/Parametric Boost (Cut)
Modulation Depth/Equalizer High Boost (Cut)
Algorithm Select, Pre-delay Time, Reverb Time
High Frequency Damping/Gate Time
Memory Number/Parametric Q Control/
OMNI ON (OFF)
Reverb Selection/Parametric Frequency Control/
Output Level/MIDI Channel/MIDI program
Number

Switches

Write, Output Level, MIDI, Chours/EQ,
Parametric EQ, Value

(Rear Panel)

Input Jacks

A, B

Remote Control Jacks

Preset Shift, Effect (ON/OFF)

MIDI Connectors

IN, THRU

MODEL DEP-5 MIDI Implementation Chart

Date : Jul. 15. 1986

Version : 1.0

Function.....		Transmitted	Recognized	Remarks
Basic Channel	Default Changed	X X	1 - 16 1 - 16	memorized
Mode	Default Messages Altered	X X *****	1, 3 OMNI ON/OFF	memorized
Note Number	True voice	X *****	X X	
Velocity	Note ON Note OFF	X X	X X	
After Touch	Key's Ch's	X X	X X	
Pitch Bender		X	X	
Control Change		X	X	
Prog Change	True #	X *****	○ 0 - 127 ** 0 - 127	
System Exclusive		X	○	Parameters
System Common	Song Pos Song Sel Tune	X X X	X X X	
System Real Time	Clock Commands	X X	X X	
Aux Messages	Local ON/OFF All Notes OFF Active Sense Reset	X X X X	X X X X	
Notes	** Program change # indicates the reference number of 'MEMORY NUMBER TABLE'.			

Mode 1 : OMNI ON. POLY
Mode 3 : OMNI OFF. POLY

Mode 2 : OMNI ON. MONO
Mode 4 : OMNI OFF MONO

○ : Yes
X : No

MODEL DEP-5 MIDI Implementation

Date : Jul. 15. 1986

Version : 1.0

1. RECOGNIZED RECEIVE DATA

Status	Second	Third	Description
1100 nnnn	Oppp pppp		Program Change ppppppp = 0 - 127
1011 nnnn	0111 1100	0000 0000	OMNI OFF
1011 nnnn	0111 1101	0000 0000	OMNI ON

2. RECOGNIZED EXCLUSIVE MESSAGES

2.1 Recognized exclusive messages for parameters

A. Program Number (PGR) for reading data (parameters) from memory. PGR indicates the 'MEMORY NUMBER'.

Byte	Description
a 1111 0000	Exclusive status
b 0100 0001	Roland ID #
c 0011 0100	Operation Code = PGR (program number)
d 0000 nnnn	Unit # = MIDI basic channel, nnnn = 0 - 15 where nnnn + 1 = channel #
e 0101 0010	Format type (DEP-5)
f 0010 0000	Level # = 1
g 0000 0000	Group # = 0
h 0000 0000	Extension = 0
i 0ppp pppp	'MEMORY NUMBER', ppppppp = 0 - 98 where ppppppp + 1 = 'MEMORY NUMBER' (1 - 99)
j 0000 0001	Reading data from memory
k 1111 0111	End of System Exclusive

B. PGR for writing data (parameters) into memory.

Byte	Description
a 1111 0000	Exclusive status
b 0100 0001	Roland ID #
c 0011 0100	Operation Code = PGR (program number)
d 0000 nnnn	Unit # = MIDI basic channel, nnnn = 0 - 15 where nnnn + 1 = channel #
e 0101 0010	Format type
f 0010 0000	Level # = 1
g 0000 0000	Group # = 0
h 0000 0000	Extension = 0
i 0ppp pppp	'MEMORY NUMBER', ppppppp = 0 - 98 where ppppppp + 1 = 'MEMORY NUMBER' (1 - 99)
j 0000 0010	Writing data to memory
k 1111 0111	End of System Exclusive

C. All Parameters (APR) for an effect parameters.

Byte	Description
a 1111 0000	Exclusive status
b 0100 0001	Roland ID #
c 0011 0101	Operation Code = APR (all parameters)
d 0000 nnnn	Unit # = MIDI basic channel, nnnn = 0 - 15 where nnnn + 1 = channel #
e 0101 0010	Format type
f 0010 0000	Level # = 1
g 0000 0001	Group # = 1
h 0vvv vvvv	Parameters (24 bytes total)
i 1111 0111	End of System Exclusive

Data (values) format for Parameters

1. REVERB SELECTION
2. OUTPUT LEVEL
3. Q OF MIDDLE FILTER
4. FREQUENCY OF MIDDLE FILTER
5. BOOST/CUT OF LOW FILTER (lower)
6. (upper)
7. BOOST/CUT OF MIDDLE FILTER (lower)
8. (upper)
9. BOOST/CUT OF HIGH FILTER (lower)
10. (upper)
11. FEEDBACK OF CHORUS (lower)
12. (upper)
13. RATE OF CHORUS (lower)
14. (upper)
15. DEPTH OF CHORUS (lower)
16. (upper)
17. ALGORITHM (lower)
18. (upper)
19. PRE DELAY or DELAY TIME (lower)
20. (upper)
21. REVERB TIME or FEEDBACK OF DELAY (lower)
22. (upper)
23. HF DAMP or GATE TIME (lower)
24. (upper)

Notes:

1. The data from #5 to #24 are pairs of nibble data (0000yyyy and 0000xxxx), and each pair forms 8-bit data (xxxxyyyy).
2. Even when there is unnecessary parameter (e.g. Reverb Time is not required nor effective for the Algorithm 1), dummy data ("0" is preferable) must be written there.
3. The actual values obtained on the DEP-5 differ from the values sent with MIDI (0-255). From the Roland distributor in your country, you can attain the table that shows how the MIDI values correspond to the actual values on the DEP-5.

2.2 Recognized exclusive messages for the 'MEMORY NUMBER' Table

A. Bulk Dump (BLD) for Memory Number Table contents.

Byte	Description
a 1111 0000	Exclusive status
b 0100 0001	Roland ID #
c 0011 0111	Operation Code = BLD (bulk dump)
d 0000 nnnn	Unit # = MIDI basic channel, nnnn = 0 - 15 where nnnn + 1 = channel #
e 0101 0010	Format type
f 0011 0000	Level # = 2
g 0000 0001	Group # = 1
h 0000 0000	Extension = 0
i 0000 0000	This number (=0) addresses the first value of 'j' to be stored in the table
j 0vvv vvvv	the 'MEMORY NUMBERS' to be stored into the Table in sequence
:	vvvvvvv = 0 - 98
:	where vvvvvvv + 1 = 'MEMORY NUMBER' (1 - 99)
:	(128 bytes total for program # 0 - 127)
0vvv vvvv	
k 1111 0111	End of System Exclusive

